

Tennessee Urban Riparian Buffer Handbook

A Practical Guide to Establishing Healthy Streamside Buffers

September 2015



Acknowledgements

Handbook Project Management, Review and Plant List Review

Reggie Reeves and Tim R. Phelps, Tennessee Department of Agriculture Division of Forestry

Handbook Development

Tim Gangaware, Ruth Anne Hanahan, Kelly Porter, Katie Walberg, University of Tennessee, TN Water Resources Research Center

Handbook Review

Rebecca Dohn, Metro Water Services; Robby Karesh, Tennessee Department of Environment & Conservation (TDEC) Division of Water Resources; Jennifer Watson, Tennessee Stormwater Association.

Plant List Review

Kasey Krouse, City of Knoxville Urban Forestry Division; Mike Berkley, GroWild, Inc.; Claude J. Bailey, Jr., Jackson State Community College; Andy Sudbrock, Nashville Natives; Andrea Sessions, Sunlight Gardens; David Arnold, Shawn Posey, T. Brian Rucker, Tom Simpson, Tennessee Division of Forestry; Allan Trently, TDEC Natural Areas Program; Todd Crabtree, TDEC Natural Heritage Inventory Program; Andrea Bishop, Caitlin Elam, TDEC Division of Water Resources; Adam Dattilo, Tennessee Valley Authority; James W. Akins, Aubrey Deck, Jason Maxedon, John Mayer, Jason Maxedon, Tennessee Wildlife Resources Agency; Matt Walker, USDA Natural Resources Conservation Service; Sharon Jean-Philippe, Ph.D., University of Tennessee, Department of Forestry, Wildlife and Fisheries; David Cook, Chris Cooper, Carol Reese, University of Tennessee Extension.



Department of
Agriculture

Forestry



Publication made possible by the Tennessee Department of Agriculture Division of Forestry under an interagency agreement with the U.S. Department of Agriculture Forest Service.

The State of Tennessee policy of non-discrimination

Pursuant to the State of Tennessee's policy of non-discrimination, the Tennessee Department of Agriculture does not discriminate on the basis of race, sex, religion, color, national or ethnic origin, age, disability or military service in its policies or in the admission or access to treatment or employment in its programs, services, or activities.

If you seek more information or feel that you have been treated unfairly in regard to the State's services or hiring practices, contact the Tennessee Department of Agriculture, EEO/AA/ADA Coordinator, P.O. Box 40627 Melrose Station, Nashville, TN 37204, 615-837-5115.

Tennessee Department of Agriculture, Auth. No. 325467, 250 copies, September 2015.

This public document was promulgated at a cost of \$9.32 per printed copy.



September 23, 2015

I am pleased to present the Tennessee Urban Riparian Buffer Handbook, a practical guide to establishing healthy streamside buffers in our state. The handbook provides a blueprint for municipal entities such as MS4 coordinators, local watershed groups, and other non-profit conservation groups for the purpose of educating and providing guidance on how to successfully plan and implement a riparian buffer project in a multitude of settings and planting conditions.

Tennessee's waterways are vital to the health of our environment. Healthy creeks, streams and rivers are dependent on healthy forested riparian buffers. These buffers offer many benefits not only to the landowner, but also to the watershed and everyone living downstream. They can help stabilize eroding stream banks, filter out sediments and chemicals before they reach the waterway, help recharge groundwater, preserve or improve wildlife and aquatic habitat, and add scenic and economic value to all landscapes.

The Tennessee Department of Agriculture Division of Forestry developed this handbook as a part of a six-year grant provided by the United States Department of Agriculture Forest Service with a goal to promote water quality in urban landscapes through tree planting activities. Establishing forested riparian buffers in priority watersheds, providing technical assistance to local planning agencies, increasing citizen awareness of water quality benefits derived from forested riparian buffers and demonstrating volunteerism in land conservation were all objectives of this project, which were focused on Davidson County to pilot the program for future expansion into other municipalities across the state. We could not be more pleased with the outcome this program has had, and we are looking forward to moving ahead and using this handbook to guide future endeavors.

In addition to the USDA Forest Service's financial support, we are very grateful for the valuable support of our partners who helped to implement the many projects carried out over the life of the grant, as well as the University of Tennessee, TN Water Resources Research Center with their expertise in developing this handbook.

I am pleased to introduce a handbook that will help us to conserve, protect and enhance Tennessee's forest resources now and for many years to come.

Sincerely,

A handwritten signature in blue ink that reads "Jere E. Jeter". The signature is fluid and cursive, written over a white background.

Jere E. Jeter, Assistant Commissioner/State Forester
Tennessee Department of Agriculture, Division of Forestry

This page intentionally left blank

Table of Contents

Introduction.....	1
The Riparian Buffer.....	3
What is a riparian buffer?.....	3
How do buffers function and what are their benefits?	3
How do buffers change over time?.....	6
Why are native plants so important to buffers?.....	6
What are the challenges of creating buffers in urban settings?.....	7
What are my options in establishing a riparian buffer?	8
How can partnerships be of assistance?	9
Assessing and Prioritizing Potential Buffer Sites	11
Creating a Riparian Buffer Plan.....	13
Access to the Waterway.....	13
Site Inventory and Planting Layout	16
Types of Available Plant Stock	17
Determining Plant Quantities	18
Selecting tree and shrub species	28
Preparing a Site for Buffer Installation.....	31
Call Tennessee811 Before Digging.....	31
Approaches to Removing Invasive Plants	32
Properly Installing Plants	35
Bare Root Seedlings	35
Container-Grown or Balled and Burlapped (B&B) Plants.....	36
Organizing and Conducting a Riparian Buffer Planting	39
Maintaining and Protecting Your Buffer	47
Informing Your Neighbors	47
Managing Vegetation	47
Removing Invasive Plants.....	48
Long-Term Protection.....	48
Glossary	51
Supplementary Resources.....	55
References	61
Photo and Illustration Credits	63
Appendices	65
A. The Tennessee Urban Riparian Buffer	A-1
B. Tennessee Riparian Buffer Site Assessment	B-1
C. Creating a Tennessee Urban Riparian Buffer Plan	C-1
D. Tennessee Native Riparian Plant List.....	D-1
E. The Threat of Invasive Plants to Tennessee Urban Riparian Buffers	E-1
F. Organizing and Conducting a Riparian Buffer Community Planting	F-1
G. Tennessee Urban Riparian Buffers: How to Plant Trees and Shrubs	G-1

List of Tables

Table 1. Functions and Benefits of Riparian Buffers	5
Table 2. Waterside Access Point Width Examples (feet)	14
Table 3. Number of Bare Root Seedlings and Shrubs Needed	30
Table 4. Spray Colors Used by Tennessee811 to Depict Type of Underground Utilities	31
Table 5. Plant Water Needs	37
Table 6. Estimated Number of Volunteers Needed for Planting Bare Root Seedlings	40
Table 7. Required Mulch Amounts	43
Table 8. Buffer Planting Project Sample Time Line.....	45

List of Figures

Figure 1. Children planting a tree	1
Figure 2. Relationship between riparian buffer width and its functions	4
Figure 3. Aerial view of a forested buffer showing that the wider the buffer the greater the ecological benefits	4
Figure 4. As the buffer matures distinctive vegetative layers are formed.	6
Figure 5. Comparison of the native plant buffer and the invasive plant impacted buffer	7
Figure 6. Stream flowing through urbanized area depicting commonly observed riparian conditions in residential, park, and commercial settings	8
Figure 7. Severe streambank erosion in urban setting.....	12
Figure 8. Native grass vs. turf grass root system	14
Figure 9a. Example of completed site inventory worksheet	17
Figure 9b. Example of completed planting sketch worksheet	17
Figures 10. Bare root seedlings.....	17
Figure 11. Container and B&B plant stock.....	18
Figure 12. Bare root seedling spacing within planting area	18
Figure 13. One-inch caliper container/B&B tree and shrub spacing	18
Figure 14. Planting sketch of one half-acre residential lot: Buffer with bare root seedlings only.....	19
Figure 15a. Planting sketch of one half-acre residential lot: Buffer with “window”, path, and visual screen of container/B&B stock	20
Figure 15b. Half-acre residential lot: Buffer with shrub window, path to water and visual screen of container/B&B stock just after planting	21
Figure 15c. Half-acre residential lot: Buffer with shrub window, path to water, and visual screen of container/B&B stock showing five years of growth	21
Figure 16a. Three-quarter acre park lot: Buffer with walking path and canoe access.....	22
Figure 16b. Three-quarter acre park lot: Buffer with walking path and canoe access just after planting	23
Figure 16c. Three-quarter acre park lot: Buffer with walking path and canoe access showing five years of growth.....	23
Figure 17a. Planting sketch of one-acre commercial lot: Buffer with bare root seedlings and visual screen of container/B&B trees and shrubs.....	24
Figure 17b. One-acre commercial lot: Buffer with bare root seedlings and visual screen of container/B&B stock just after planting	25

Figure 17c. One-acre commercial lot: Buffer with bare root seedlings and visual screen of container/B&B stock showing five years of growth	25
Figure 18a. Planting sketch of three-quarter acre park lot: Buffer with only container/B&B stock	27
Figure 18b. Three-quarter acre park lot: Buffer with only container/B&B stock just after planting	27
Figure 19. Spicebush Swallowtail Butterfly, <i>Papilio troilus</i>	29
Figure 20. The Nature Conservancy's Weed Control Methods Handbook	32
Figure 21. Weed Wrench™	32
Figure 22. Application of herbicide with dye to tree stump	33
Figure 23. Bare root seedling in 2-ft diameter hole.....	35
Figure 24. Bare root seedling planted in hole with backfill soil being tamped down	35
Figure 25. Dig hole that is twice the width of the root ball of a container/B&B plant.....	36
Figure 26. Place B&B plant into hole and backfill with soil.....	36
Figure 27. Mulch application around newly planted tree	37
Figure 28. Example of “volcano mulching”	37
Figure 29. Shovels and buckets laid out for volunteers	42
Figure 30. Volunteers planting bare root seedlings during dormancy months.	44
Figure 31. Example of signage for notifying and educating neighbors about buffer installation.....	47
Figure 32. Example of a “No Mow Zone” sign that also educates passers by	49
Figure 33. Temporary fencing to protect newly installed seedlings at South Doyle Middle School on Baker Creek, Knoxville, TN.....	49
Figure 34. Buffer site before planting	50
Figure 35. Buffer site just planted with B&B/container edge trees and bare root seedlings	50
Figure 36. Buffer site 1.25 years after planting.....	50

This page intentionally left blank

Introduction

Riparian buffers encompass a diverse mix of vegetation along waterways and are the first line of defense in maintaining the health of Tennessee's waterways. This Handbook is intended to help those who want to protect our waterways by establishing buffers across our state's rapidly changing landscape including:

- Local governments (public works, parks, or stormwater departments)
- Non-governmental organizations (watershed groups)
- Community groups (civic groups)
- Water-side property owners (homeowners, HOAs)



Figure 1. Children planting a tree

This Handbook contains:

- Information on establishing riparian buffers in a range of urban settings (residential, public, and commercial).
- A step-by-step guide on how to plan, conduct and evaluate a volunteer riparian planting.
- A set of handouts that can be used when preparing volunteers and community partners for the coordination and implementation of riparian plantings.
- A regionalized riparian buffer plant list.

Ways to use this Handbook:

- As a road map providing the framework, practical tips and resources needed for planning a successful urban riparian planting event.
- As a tool to help you consider the specific social and ecological needs of your community's urbanized waterside areas and to adapt your buffer designs and planting installations to them.
- As a training guide to prepare a landowner or community group to install a riparian buffer.

To download the latest edition of the Handbook and its associated materials from the web go to <http://tn.gov/agriculture/topic/ag-forests-urban>.

IMPORTANT: This is not a regulatory handbook. The Tennessee Department of Environment and Conservation (TDEC) along with many municipalities have buffer requirements under certain land use conditions (<http://www.tn.gov/main/section/local>). Please refer to these agencies if seeking guidance for meeting these regulations; consider this Handbook as an aid in meeting these requirements.

This page intentionally left blank

The Riparian Buffer

Coming together as a community to install riparian buffers is a great way to get the work done, build relationships, and instill a sense of local pride and environmental stewardship. It is also a prime opportunity to educate those involved along with neighboring landowners about riparian buffers. This section introduces you to the information that can be included in educational messages to the public including the functions, benefits and ecology of buffers. It also covers the challenges of installing buffers in urban settings and the partnerships that you may want to cultivate in support of your buffer project. **Appendix A** provides an accompanying handout that can be used when talking with the public on these topics.

What is a riparian buffer?

A riparian buffer is the transitional area between land and water that contains a mix of trees, shrubs, grasses and wildflowers. This vegetated strip of land “buffers” the waterbody from human impacts such as residential development and agricultural activities and is a primary defense in the protection of our waterways.

In defining riparian buffer, you may also consider the following:

- The word “riparian” is derived from the Latin term, “ripa,” which means bank.
- The riparian buffer can be thought of from a linear perspective, providing habitat connectivity between adjoining properties and is then often referred to as a “riparian corridor.”
- The word **buffer** means something that cushions against the shock of something else (noun) or cushions the shock (verb).

How do buffers function and what are their benefits?

A healthy riparian buffer brings with it a broad range of environmental, economic, and social functions that are of significant benefit and value to our communities. Table 1 outlines these while Figure 2 demonstrates a fundamental buffer concept—the wider the buffer, the more functions it will serve and the more benefits it will provide.

The Wider the Buffer the Greater the Benefits

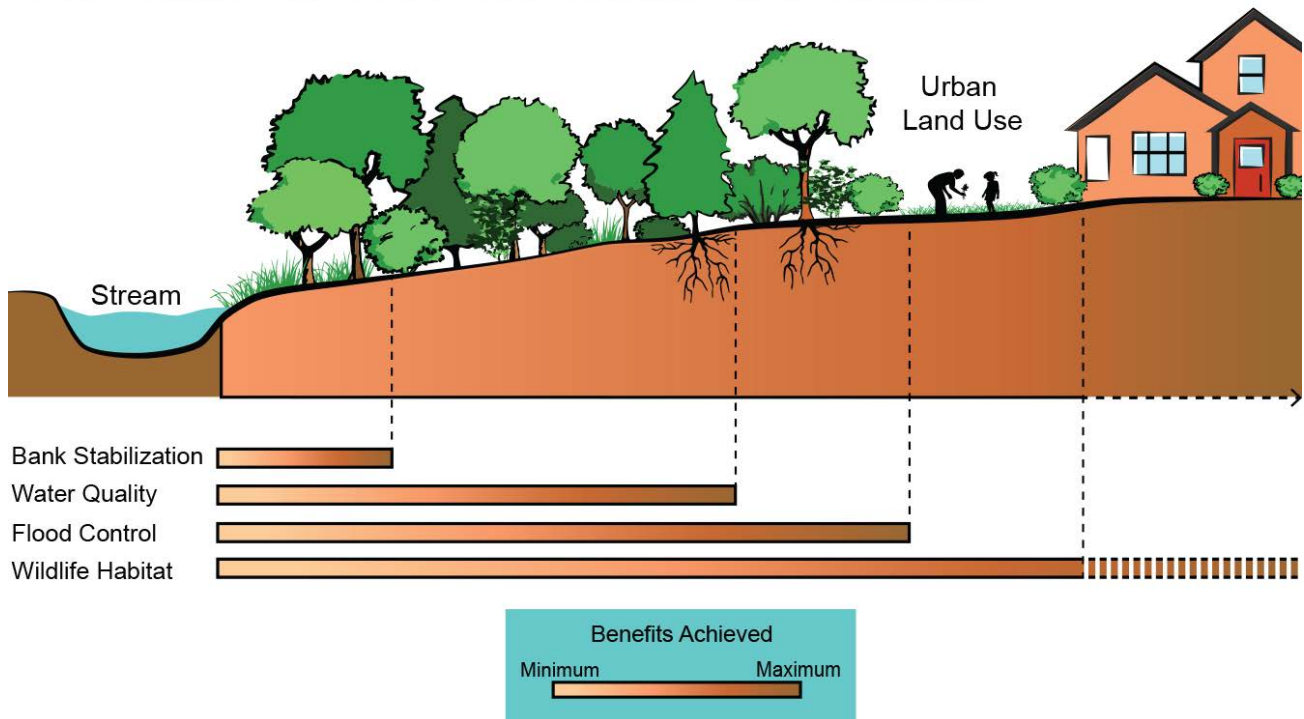

Figure 2. Relationship between riparian buffer width and its functions (adapted from Hawes and Smith, 2005). Distance of benefits varies due to site conditions such as slope.



Figure 3. Aerial view of a forested buffer showing that the wider the buffer the greater the ecological benefits (Image ©2014 Google Earth).

Table 1. Functions and Benefits of Riparian Buffers

Functions	Benefits
<p><u>Stabilizes waterway banks</u></p> <ul style="list-style-type: none"> • Plant roots bind soils holding bank soils in place • Reduces bank erosion 	<ul style="list-style-type: none"> • Reduces a primary aquatic pollutant, sediment • Lessens property loss • Minimizes safety hazards created by unstable streambanks
<p><u>Creates habitat</u></p> <ul style="list-style-type: none"> • Aquatic – within the waterway <ul style="list-style-type: none"> » Contributes leaves and other organic matter that are food sources for insect larvae and other bottom-dwelling organisms that provide food for fish » Shades the waterway and cools the water temperatures » Root-reinforced banks help to create meandering form of streams and habitats like pools where fish spawn. » Produces woody debris and leaves that diversify habitat • Terrestrial – along the waterway <ul style="list-style-type: none"> » Provides food and shelter for wildlife » Serves as corridors for wildlife movement throughout urban landscapes 	<ul style="list-style-type: none"> • Increases aquatic and wildlife biodiversity • Improves waterway and streamside recreational opportunities • Provides eco-friendly tourism opportunities (e.g. bird watching)
<p><u>Filters stormwater pollutants</u></p> <ul style="list-style-type: none"> • Slows down and traps pollutants like nutrients, sediment, and pathogens being carried in stormwater • Allows for pollutants to infiltrate the soil, be broken down by soil microbes, and be absorbed by plants 	<ul style="list-style-type: none"> • Improves overall water quality • Enhances waterway's recreational value
<p><u>Provides flood storage</u></p> <ul style="list-style-type: none"> • Creates space for storing excess water from heavy rains • Provides area for sediment in flood waters to drop out, improving water quality while also building the floodplain • Allows for infiltration and vegetative uptake of floodwater 	<ul style="list-style-type: none"> • Reduces property damage to the built community • Improves health of floodplain

How do buffers change over time?

A riparian buffer changes in both appearance and function over time through a process referred to as *ecological succession*. From planting to maturity, these changes can be categorized into three stages:

- 1. Early:** Soon after installing tree and shrub seedlings in an open sunny streamside area, many opportunistic plants will seek to establish themselves, competing for space, nutrients and sun. This will include herbaceous unwanted plants (aka weeds) that result in an “unkept” or “wild and wooly” appearance. You can expect this kind of appearance for at least the first five years unless you opt to selectively cut or apply herbicide to these “volunteer” plants. A planted edge of native trees and shrubs can help screen this “unkept” appearance of the buffer during its early successional stages.
- 2. Middle:** Eventually as the installed shrubs and trees gain height, they will begin to provide shade. The shade will help to suppress weed growth, providing the shrubs and trees with a competitive edge.
- 3. Late:** After eight to ten years, the buffer will begin to take on more of the characteristics of a mature and healthy woodland, with distinctive vegetative layers. The upper layer or *canopy* serves the critical function of providing shade for the adjacent waterbody, cooling water temperatures needed for healthy aquatic life. The canopy and *subcanopy* (*lower canopy*) layers create an environment for the understory tree and shrub species that require less light. This space should contain a range of plants of varying heights and is important habitat for native birds and other wildlife.

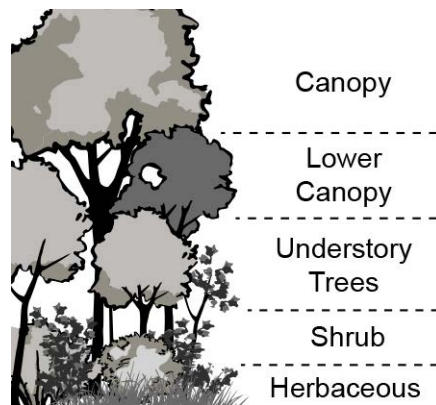

Figure 4. As the buffer matures distinctive vegetative layers are formed.

Why are native plants so important to buffers?

Native plants are those that naturally occur in a region or habitat and have co-evolved over geologic time with other plants and animals to develop specialized ecological relationships. They serve vital ecological roles, creating a balanced plant community that supports indigenous wildlife.

In contrast, nonnative plants, particularly those that are invasive, can play havoc to the structure and composition of a riparian buffer by outcompeting native plants and creating dense subcanopy layers of one to two species. These layers can be damaging to wildlife and aquatic habitat while also creating an undesirable dense visual and physical barrier between an upland property and the waterbody. The invasive plant problem can be worsened when a buffer is limited in width. In

this situation, the light along the buffer edges can easily penetrate throughout the vegetation, disrupting the canopy layers from shading out unwanted plants. This phenomenon is referred to as the “edge effect” and can be reduced by planting wider buffers that result in more natural forest layers.

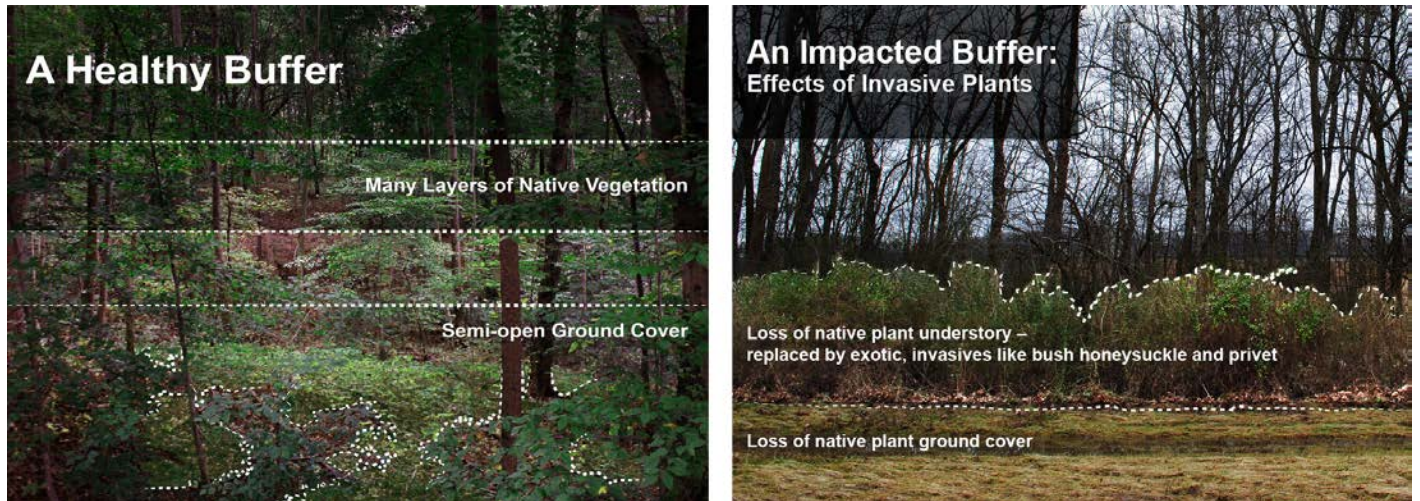

Figure 5. Comparison of the native plant buffer and the invasive plant impacted buffer

What are the challenges of creating buffers in urban settings?

Urban areas contain a range of challenges for establishing healthy riparian buffers and the installation of the ideal buffer may simply not be feasible. In older developed areas, streamside development may have occurred before there were any building restrictions. Of the “pocket” streamside areas not developed, they may be now filled with debris and invasive plants.

In these urbanized situations, consider three important tenets:

- Some buffer is better than no buffer.
- The wider the buffer, the more environmental, economic, and social benefits the buffer will provide (see Figures 2 and 3).
- Not all buffers are created equal. The types of plants make a difference in how effectively buffers can function (see Table 1). For example, vegetation comprised solely of grasses will not adequately protect the streambank against erosion, while one comprised solely of shrubs will not provide sufficient shading for the adjacent waterbody.

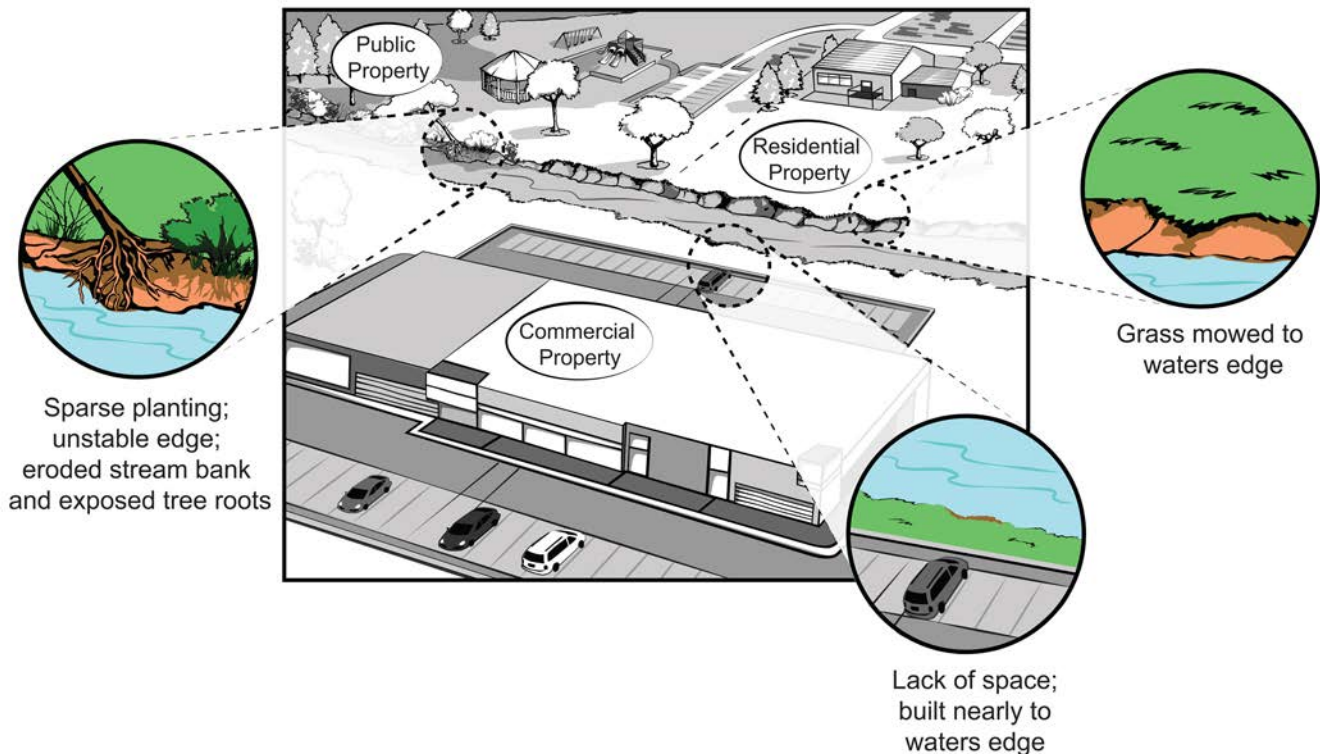

Figure 6. Stream flowing through urbanized area depicting commonly observed riparian conditions in residential, park, and commercial settings

What are my options in establishing a riparian buffer?

There are two ways to consider establishing a buffer—one requires minimal resources, the passive approach, and the other where the buffer is planned and installed, the actively established buffer.

The passive approach allows a riparian area that is currently being mowed or grazed to naturally colonize and mature into a forested area through ecological succession. No planting is done and it is typically protected by creating a “no mow zone” area through signage and/or fencing. While this approach requires minimal time and financial resources, it does have its drawbacks. If initially limited only to successional vegetation, the buffer will take longer to establish, allowing more time for streamside damage to occur. There is also no control over species selection, increasing the likelihood for more undesirable species to colonize.

An actively established buffer is the focus of this Handbook. Under this approach the buffer is intentionally planned and installed, which allows for more control of the composition of the buffer and its appearance. An actively established buffer can also ensure that the buffer’s ecological functions are maximized. The drawback is that it does require planning time and financial resources to cover

plant costs and the modest expenses associated with a community planting event. That is where community partnerships can offer assistance.

How can partnerships be of assistance?

You and your community group may be new to the process of establishing a streamside buffer and need help. First, consider your local municipality and the range of professionals it may be able to provide, such as those from:

- Public works/stormwater departments
- Soil conservation programs
- Extension services
- Parks

Professionals from these areas may help identify potential buffer installation sites and evaluate them. They may also be a source of volunteers and needed supplies.

Partnerships are two-way streets and can be advantageous to local government agencies. Involving community groups in establishing buffers is integral to their long term success. For example, municipal stormwater programs have *Clean Water Act* mandates to educate citizens on, and involve them in, protecting our waterways. Partnering with community groups on buffer plantings offers the stormwater programs an ideal way to satisfy multiple permit requirements.

Broaden Your Partnership Horizons

Brainstorm potential partners within your community who have a stake in clean water or in the protection of our environment.

- Utilities
- Recreational enthusiasts (hiking, canoeing groups)
- Birding associations
- Outfitter businesses
- AmeriCorps and Vista programs
- Watershed/conservation groups

This page intentionally left blank

Assessing and Prioritizing Potential Buffer Sites

Your community likely has multiple sites in need of a healthy riparian buffer. This section provides a scoring process that can be used as a tool in ranking potential sites. It involves answering five questions and is included on the “Tennessee Riparian Buffer Site Assessment” found in **Appendix B**. A “no” answer to the first question eliminates that site as a candidate. Assign one point for a “yes” answer to questions #2 through #5. The sites with the lowest total scores are given first priority in planting.

1. Is the landowner supportive of the riparian planting and willing to ensure that the riparian buffer will be protected? If NO, eliminate this site as a candidate.

This is a critical element in determining the long-term success of your project. The landowner must also be willing to consider a viable means of protecting the planted vegetation from mowing and herbicides. The approach may vary by how the land is being used. For example, a government-owned property (e.g., library, park, etc.) may establish a “no-mow zone.” A commercial business landowner may incorporate buffer maintenance requirements into a landscape management contract.

2. Does the buffer contain a mix of trees, shrubs, and herbaceous plants (grasses, wildflowers)? Yes (1) or No (0)

An ideal buffer contains a mix of native vegetation that maximizes a buffer’s functions and benefits (see Table 1). For example, if the area is mostly grasses, it would receive a score of zero.

3. Is the width of the existing buffer (mix of trees, shrubs, grasses) on each side of the bank at least twice the width of the waterbody? Yes (1) or No (0)

This question assesses whether there is currently an adequate buffer width and is based on a Natural Resources Conservation Service (NRCS) guideline.

4. Does the site offer shading to the stream or contain seedlings or saplings that will mature into shade-bearing trees? Yes (1) or No (0)

A critical function of an urban buffer is to provide at least partial shading to the adjacent waterway to allow for cooling of its waters. Many aquatic insects and fish cannot survive in warm waters and in urban areas where the source of runoff is often from blacktop, shading by trees is of utmost importance.

5. Are the banks free of active excess erosion? A good indication is that you can walk along the edge without concern of a bank collapsing. Yes (1) or No (0)

Actively eroding streambanks are an indication that there is insufficient root protection being provided by the streamside plants. In urban areas where the water flows can be “flashy” (i.e., rise and fall quickly) and carry a great deal of energy, it is particularly important that the stream banks be well protected by an extensive and deep root system.



Figure 7. Severe streambank erosion in urban setting

Creating a Riparian Buffer Plan

Once you have identified a riparian site for planting, a plan needs to be created that lays out a planting strategy. This section describes an approach which uses cost-saving bare root seedlings as the primary plant stock and a single planting density, regardless of species. It is not an approach a landscape designer would take when creating a more manicured or groomed landscape appearance; however that is not its intent. Rather by the very nature of a healthy buffer, the planted riparian area is intended to mimic Mother Nature, resulting in a more randomized and naturalized appearance.

As a part of the buffer plan, a site inventory needs to be conducted and a planting schematic created. **Appendix C** provides a buffer planning handout that includes worksheets for these. The planting schematic dictates the number and types of plants to be installed and, to a certain degree, installation logistics. **Appendix D** provides a native plant list that can be used to help select the specific plant species desired for the buffer area.

The buffer plan can be as simple as a roughed out sketch. However, it should take into account the current site conditions; how the landowner plans to use the site (e.g., access to fishing); and whether the landowner prefers to incorporate larger plant stock for the purposes of, for example, creating visual screens. The key to the plan's usefulness is ensuring the right questions are answered in its development. This section will help by asking those questions.

Access to the Waterway

Waterways can offer immense enjoyment from their relaxing sights and sounds to opportunities for recreation. It may be important to the buffer landowner to have visual and/or physical access to the waterway to accommodate one or more of these types of desired uses. For example, a path may be incorporated so that a family visiting a park can have a streamside picnic or a "window" may be created to a creek so a homeowner can have a water view. Utility companies may also use buffer areas to run above and below ground utilities and both need to be considered in the buffer plan.

Physical Access

Physical access points to a waterway may be desired for fishing, canoe launching, or picnicking. When planning, consider the following questions:

- What is the intended use(s) of this access?
- What ways could this access be used that are undesirable?
- Do the benefits of having this access outweigh the potential drawbacks?

Once the uses are identified, the access point can be designed to meet those needs and to a certain extent, designed to limit unintended uses. Three design factors include access width, ground cover, and bank stability.

1. Access Width

Identify the narrowest possible width for the access point's intended use(s). For example, a three-foot-wide path may be sufficient for a homeowner who only plans to use the access for fishing. It may also limit unwanted uses by being narrow enough to go unnoticed or too narrow for unintended purposes.

Homeowner fishing	3 ft
Picnic area with table	6-8 ft
Kayak/canoe launch	6-12 ft

2. Ground Cover

It is important to ensure that any exposed soils that could become a sediment source for the waterway are limited. Paths can be planted and maintained in grasses or they may be covered in wood chips. Both options have their benefits and limitations.

Grasses may be more appropriate for wider pathways that offer sufficient sun exposure. Consideration may be given to installing a mix of low-growing native grasses such as Buffalo Grass and Blue Grama that provide a deeper root system for more effective erosion control.

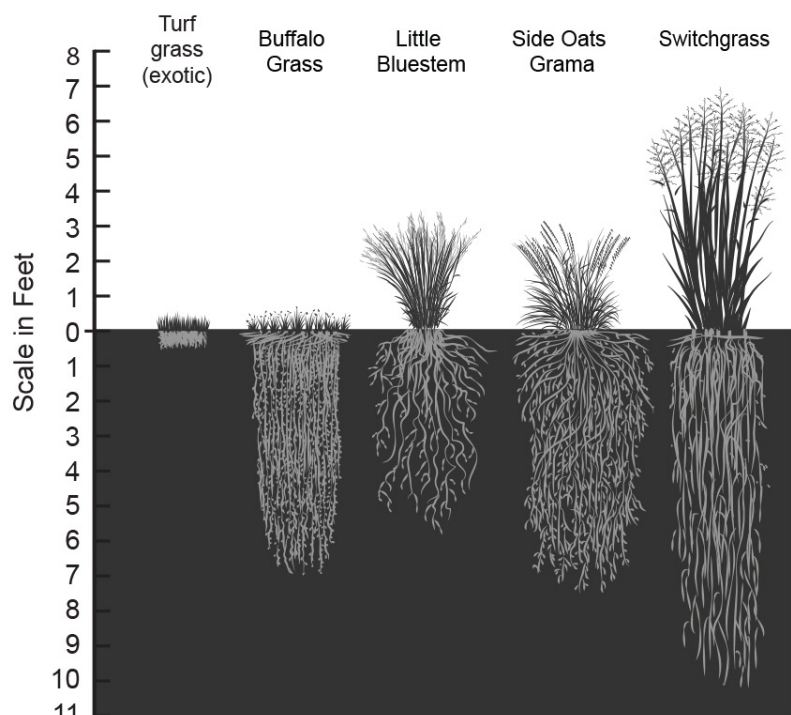

Figure 8. Native grass vs. turf grass root system

Initially narrow paths may be planted in grasses but over time, they may be shaded out by adjacent shrubs and trees and require another option

such as wood chips. Many tree service companies will provide wood chips for free and may also deliver them when working in an area, while some municipalities may offer free or low cost mulch through their solid waste departments. The downside of using wood chips is that they may wash away during flooding and periodically need to be replenished.

3. Bank Stability

The bank fronting a waterway's access point should be planted minimally in low growing shrubs to offer protection from bank erosion. If a canoe or kayak launch is desired within the buffer, additional factors need to be considered including safety. The National Park Service's Rivers and Trails program provides a comprehensive design guide for a range of canoe and kayak launches entitled "Logical, Lasting Launches," http://www.nps.gov/ncrc/programs/rtca/helpfultools/ht_launch_guide.html, that can provide technical guidance.

Visual Access to the Waterway

"Windows" to a waterway in riparian buffers may be created by strategically placing swaths of low-growing shrubs (see Appendix D) among the mix of taller growing trees and shrubs. In some urbanized situations, such as on school campuses, this may be necessary to create visual lines of site from one area of the campus to another. If this is being considered in the riparian plan, consider the following questions to help determine window width and placement.

1. Where will the viewer(s) most likely be located?
2. What is the narrowest width that can be used to meet site needs?
3. Is the access worth the long-term maintenance requirements?

It is important to consider the vantage point of the water viewers. If it is from a home on an upland slope from the waterway, the windows may not be necessary. The narrowest window option is always preferable since the streamside placement of only low-growing shrubs eliminates the buffer benefit of shading the adjacent waterway. There is also the consideration of long-term maintenance of these windows. With them being flanked by taller trees and shrubs, it is inevitable that taller shrubs and trees will migrate into the area requiring periodic removal.

Utility Line Access

Utility companies have easements to run lines through properties and most have planting restrictions as a part of the easement agreements. For above ground power lines, there are typically limitations on installing plants of a certain height. It is always important to contact the utility company to determine their planting requirements. Some companies require that a planting plan be submitted before planting is allowed. The risk of not contacting the company is that your installed plants may be mowed or sprayed with herbicide.

By state law, you are required to contact Tennessee811 to have underground utilities marked before any digging at the buffer site can occur. Refer to the “Preparing a Site for Buffer Installation” section for more details on this critical service. According to Tennessee811, no digging should occur in the width of utilities plus 24 inches; however, it is important to check with your local utility company. For example, Nashville’s Metro Water Services (MWS) requires no digging/planting take place within 10 feet either side of their underground sewer and water lines, and the Tennessee Valley Authority (TVA) has restrictions on plantings within their right-of-ways, which are typically between 50 and 200 feet wide. For more information on TVA right-of-ways, see <http://www.tva.com/power/rightofway/faq.htm>.

Site Inventory and Planting Layout

Key information about the targeted buffer site needs to be collected in order to create a planting plan. The most effective way to collect this information is to visit the site to make and record observations. **Appendix C** contains worksheets that can be used for creating your plan. One is for the site inventory (see Figure 9a) where information such as the following can be sketched:

- Native plants to be retained
- Non-native, invasive plants to be removed
- Saturated “soggy” ground (may be indicated by water-loving plants likes sedges or rushes)
- Above-ground utilities and signs of underground utilities
- Potential safety hazards (e.g., holes in ground) to consider on the day of planting
- Adjacent buildings, taking note of vantage points to the buffer (e.g., from patio)

It may be useful when conducting your inventory to be accompanied by a person who can identify plant species. This may be a County Extension agent or plant specialist from a nature park or community college.

The other worksheet is the planting sketch (see Figure 9b) that should include the features that will affect the sizes of the planting areas. These could include:

- Walking paths(s)
- “Windows” for visual access to the waterway
- Kayak access
- Streamside picnic area
- Above and underground utilities

The scale of the grid can be adjusted according to the size of the site.

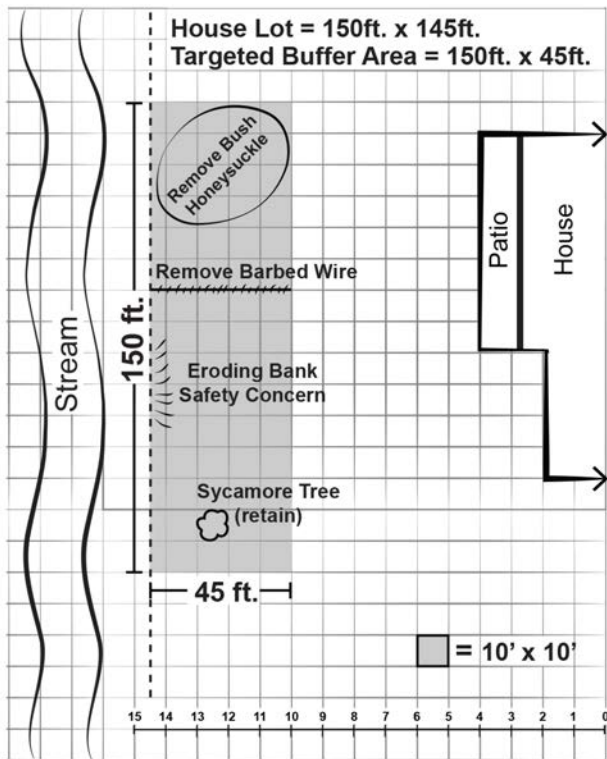

Figure 9a. Example of completed site inventory worksheet

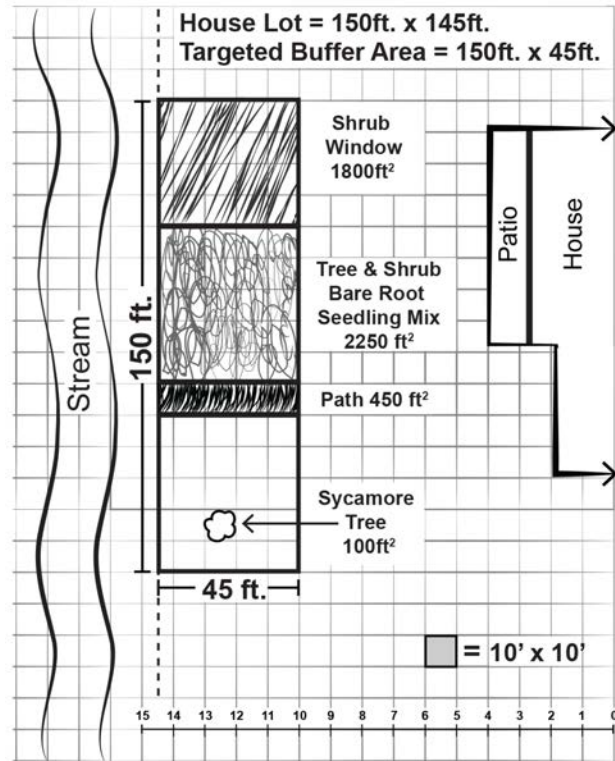

Figure 9b. Example of completed planting sketch worksheet

Types of Available Plant Stock

The primary plant stock used in buffer plantings is bare root seedlings. Bare root seedlings are very young trees and shrubs (generally less than two years old) dug in dormancy from production fields with no soil retained on the roots. These are typically purchased on-line, are dug immediately before shipping, and come with their roots exposed. The other plant stock are more mature plants that are sold in containers (grown in container for generally a year) or in a “balled and burlapped” form (roots remain covered by a ball of soil that is wrapped in burlap and tied with wire or twine).

Bare Root Seedlings

- Preferred for mass riparian plantings due to their lower cost and ease of transport and installation.
- Available from the Tennessee Division of Forestry (TDF) Nursery, <http://www.PlantTNTrees.org>, and other mail order nurseries (Check on availability since nurseries only dig seedlings during certain times of the year).
- Plant during dormancy from January through March



Figures 10. Bare root seedlings

Container and Balled & Burlapped (B&B) Stock

- Sold in local nurseries and retail garden centers at a much higher cost than bare root seedlings.
- Can be of particular benefit along buffer edges as a screen and to create a more groomed edge.
- Plant during dormancy from November through March.

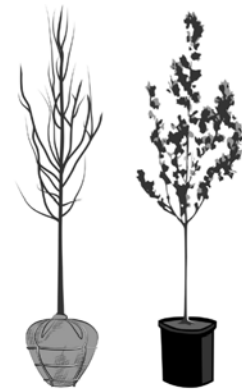

Figure 11. Container and B&B plant stock

Determining Plant Quantities

The type of plant stock will determine how the plants are spaced or their planting density.

Bare root seedlings are to be placed about six feet apart from one another. Another way to visualize this spacing is that the seedling is located in the center of a 36 foot square. The reason for this “one size fits all” planting density is to ensure a high density planting that maximizes stormwater and water quality benefits and allows for some expected mortality of seedlings.

Container or B&B plant stock are generally used in lesser quantities due to their cost and are more strategically placed. A primary use of these trees and shrubs can be to serve as a visual screen between a buffer and an upland area (see Figure 13). A homeowner, for example, may want to block the “messy” appearance of the buffer as it goes through its early successional stages. A recommended width between these larger container or B&B plants is about 10 feet. By alternating trees and shrubs more visual interest and diversity can be created.

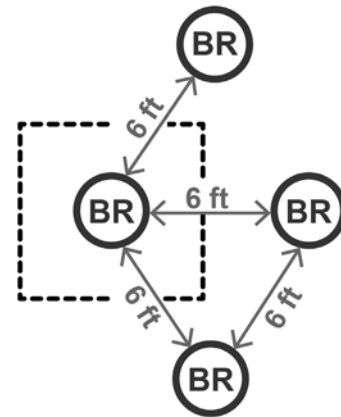

⊙ = bare root seedling

Figure 12. Bare root seedling spacing within planting area

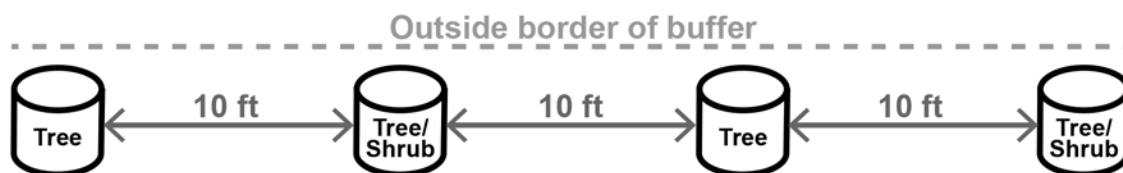

Figure 13. One-inch caliper container/B&B tree and shrub spacing

Knowing the size of a planting area and the planting density, plant quantities can easily be determined. The following examples include buffer planting plans for a home, park, and business on three different lot sizes bordering a stream:

One Half-Acre Residential Lot: Buffer with Bare Root Seedlings Only

In this residential scenario, the residential lot is one half-acre which is average for Tennessee. The lot borders 150 linear feet of stream and the buffer is 45 feet wide.

Plan: The entire buffer area is to be planted with bare root seedlings.

Total Planting Area = 45 ft X 150 ft = 6750 ft²

Thirty-six square feet is allocated for each seedling so the total area would be divided by 36 ft² to determine the number of seedlings to be planted in that area.

of Bare Root Seedlings = 6750 ft² / 36 ft² = 188

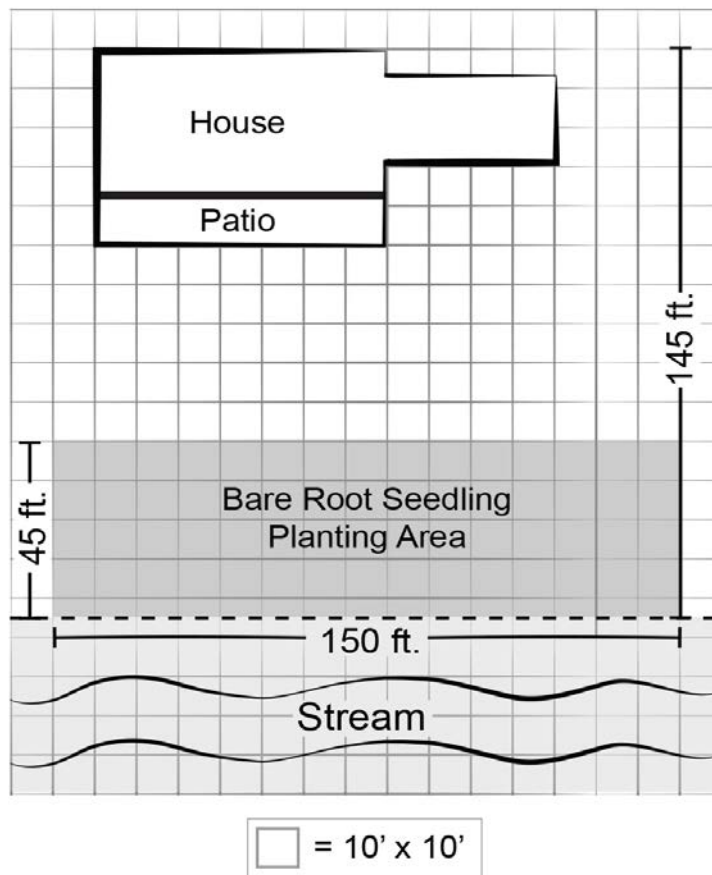

Figure 14. Planting sketch of one half-acre residential lot: Buffer with bare root seedlings only

One Half-Acre Residential Lot: Buffer with “Window”, Path and Visual Screen

The lot dimension in this residential scenario is the same as the first example. However, this landowner would like a view of the creek, an access path for fishing, and a visual screen of trees and shrubs to block the “messy appearance” of the growing buffer.

Plan: A “window” with shrubs of low to moderate height will be located in front of the home’s front porch and a mulch walking path to the stream will be installed. A row of container/B&B trees/shrubs will be planted along the inside edge of the buffer to serve as a visual screen.

Total Buffer Area = 45 ft X 150 ft = 6750 ft²

Path = 45 ft X 10 ft = 450 ft²

“Shrub Window” Planting Area = 45 ft X 30 ft = 1350 ft²

Tree/Shrub Planting Area = 6750 ft² - 450 ft² - 1350 ft² = 4950 ft²

of Bare Root Seedlings

- Tree/Shrub Mix = 4950 ft² / 36 = 138
- Shrub Window = 1350 ft² / 36 = 38

Container/B&B Stock

- 150 ft buffer length - 30 ft shrub window - 10 ft path = 110 linear ft
- 110 linear ft / 10 ft spacing = 11

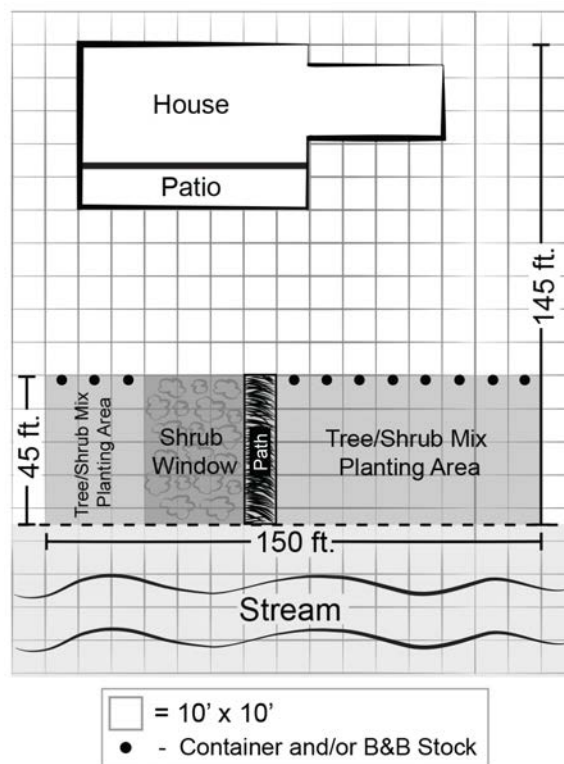

Figure 15a. Planting sketch of one half-acre residential lot: Buffer with “window”, path, and visual screen of container/B&B stock

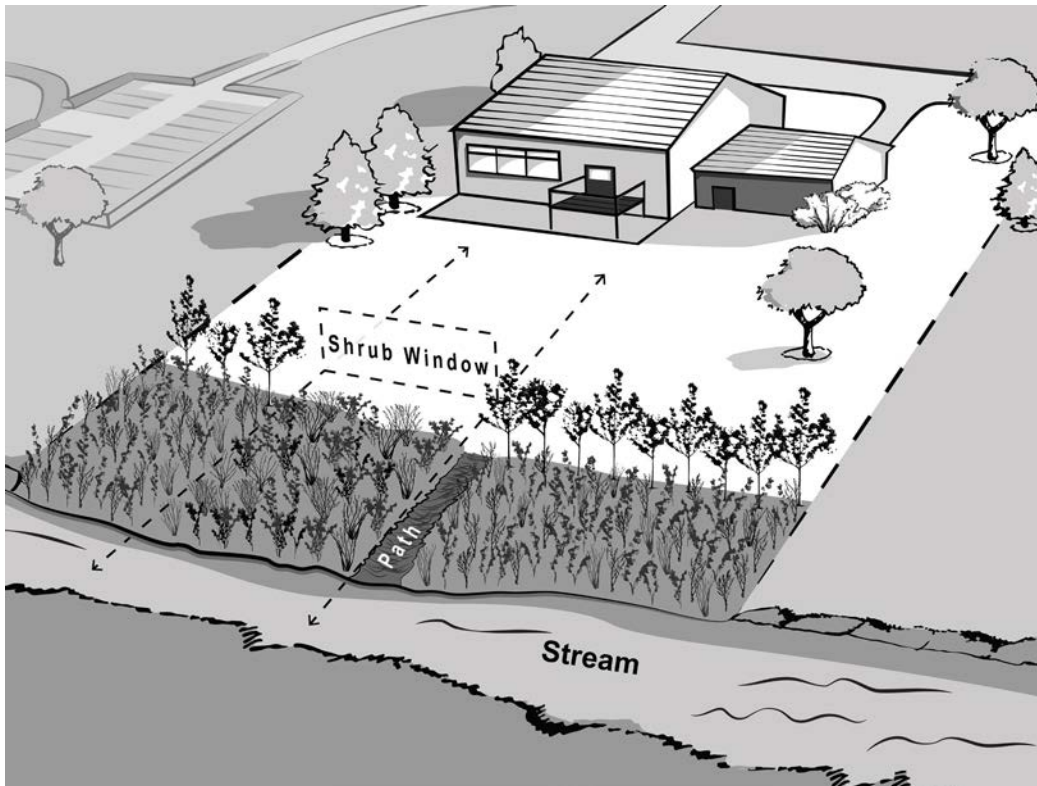

Figure 15b. Half-acre residential lot: Buffer with shrub window, path to water and visual screen of container/B&B stock just after planting

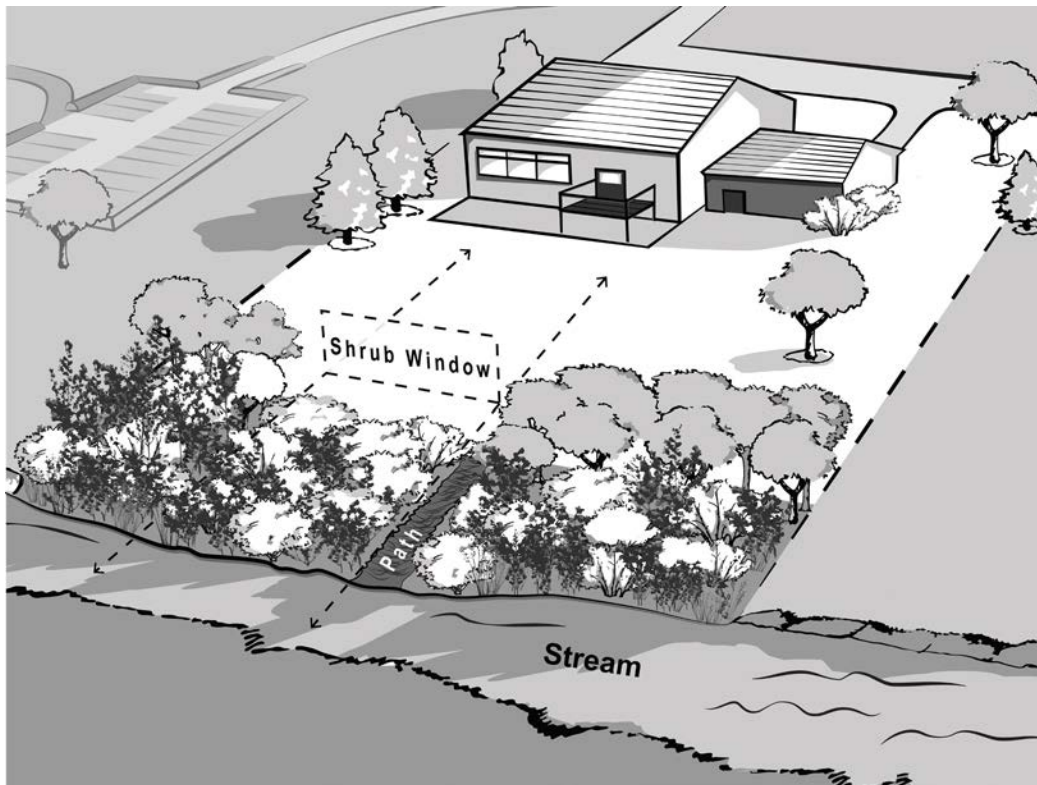

Figure 15c. Half-acre residential lot: Buffer with shrub window, path to water, and visual screen of container/B&B stock showing five years of growth

Three-Quarter Acre "Open Space"/Park Lot

In this park scenario, the lot size is three-quarter acre with 180 linear feet bordering the stream.

Plan: There will be two paths—one five-foot wide for walking and one 10-foot wide for canoe access—together, reducing the planting area by 675 ft².

Total Buffer Area = 45 ft X 180 ft = 8100 ft²

Walking Path = 45 ft X 5 ft = 225 ft²

Canoe Access = 45 ft X 10 ft = 450 ft²

Total Planting Area = 8100 ft² - 675 ft² = 7425 ft²

of Bare Root Seedlings = 7425 ft² / 36 = 206

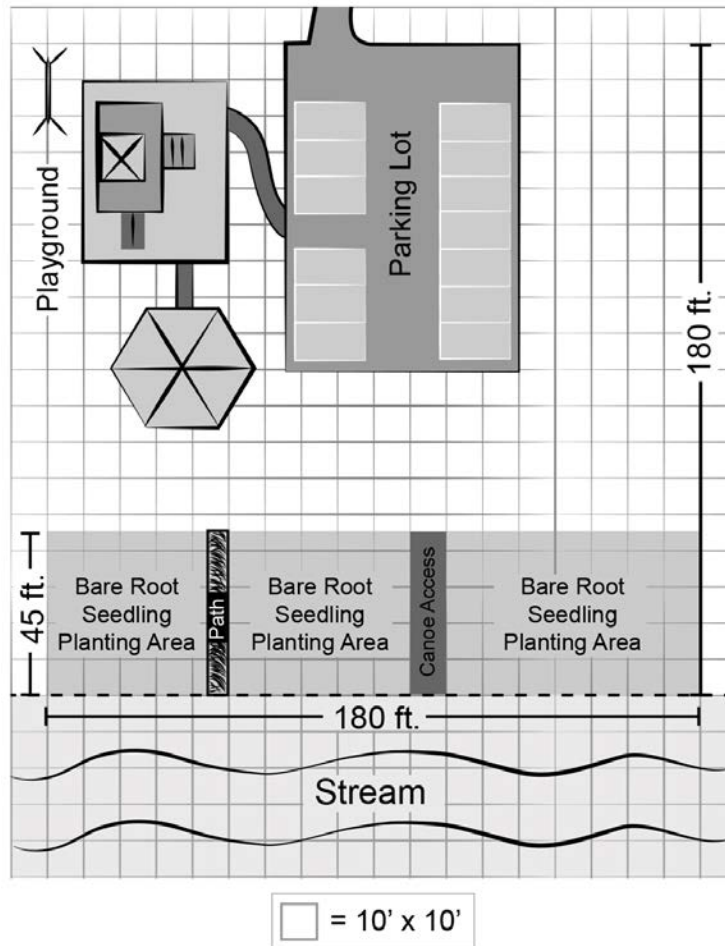

Figure 16a. Three-quarter acre park lot: Buffer with walking path and canoe access

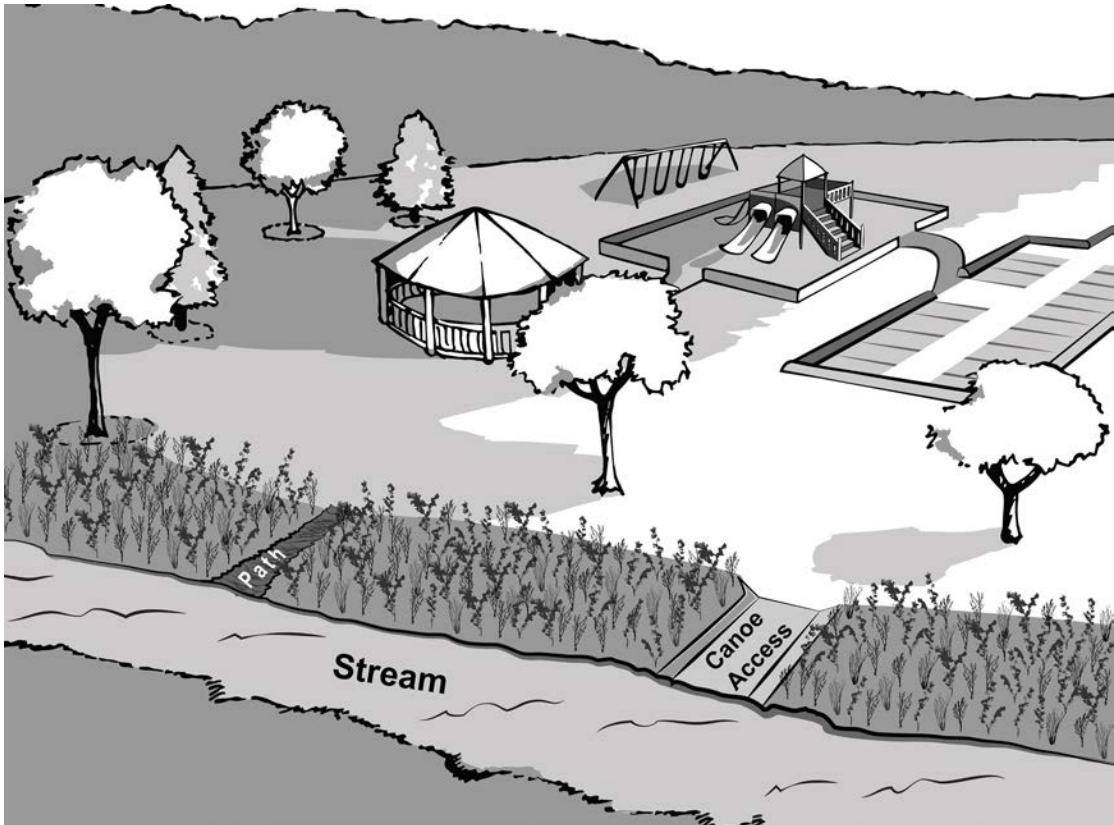

Figure 16b. Three-quarter acre park lot: Buffer with walking path and canoe access just after planting

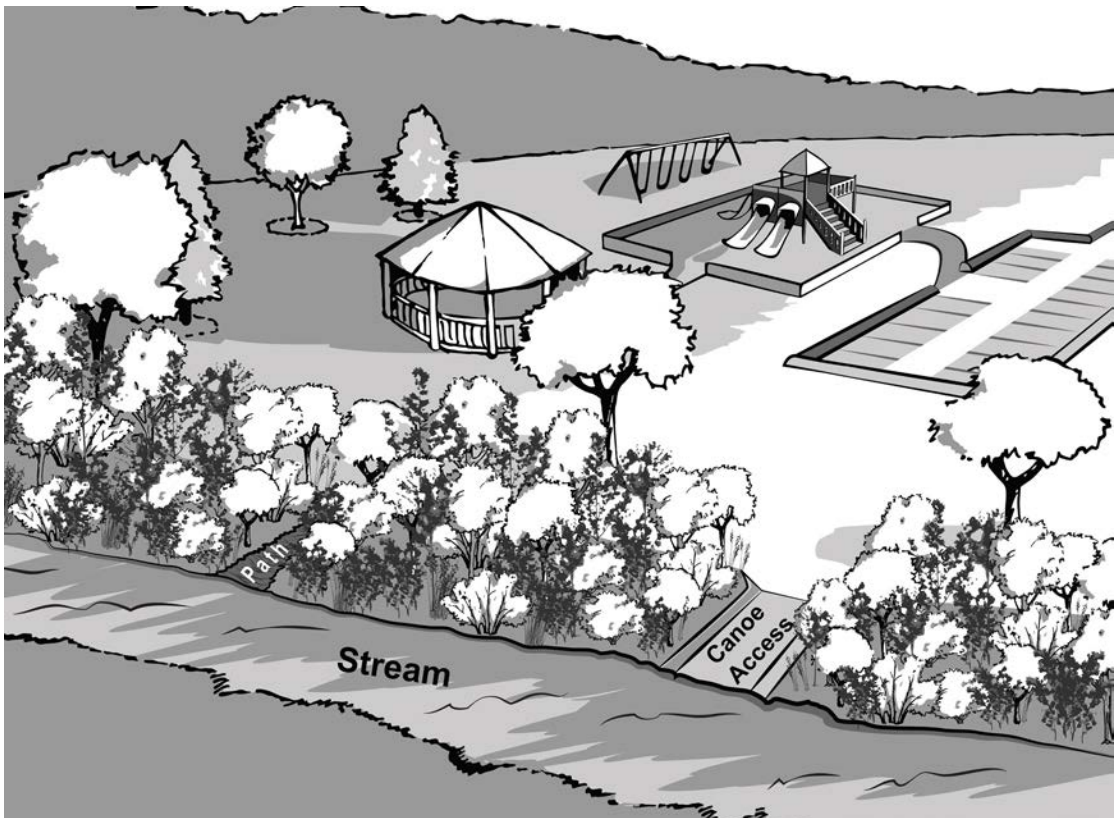

Figure 16c. Three-quarter acre park lot: Buffer with walking path and canoe access showing five years of growth

One-Acre Commercial Lot: Buffer with Screen of Container Stock

In this commercial scenario, the lot size is one acre with 250 feet of stream frontage. The parking lot extends along the stream for 190 feet and is about 20 feet from the water's edge.

Plan: Along the parking lot adjacent to the stream, a 10-ft wide strip of tree and shrub bare root seedlings will be planted. Within five feet of the parking lot and running parallel to it, a row of container/B&B trees/shrubs will be planted to serve as a visual screen. On either side of the parking lot (30 feet on each side), the planted buffer width will be widened to 45 feet and again be bordered by the container/B&B trees/shrubs.

Total Buffer Area =

In front of parking lot = 10 ft X 190 ft = 1900 ft²

Combined area on either side of parking lot = 60 ft X 45 ft = 2700 ft²

1900 ft² + 2700 ft² = 4,600 ft²

of Bare Root Seedlings = 4,600 ft² / 36 ft² = 128

of Container/B&B Stock = 250 ft / 10-ft spacing = 25

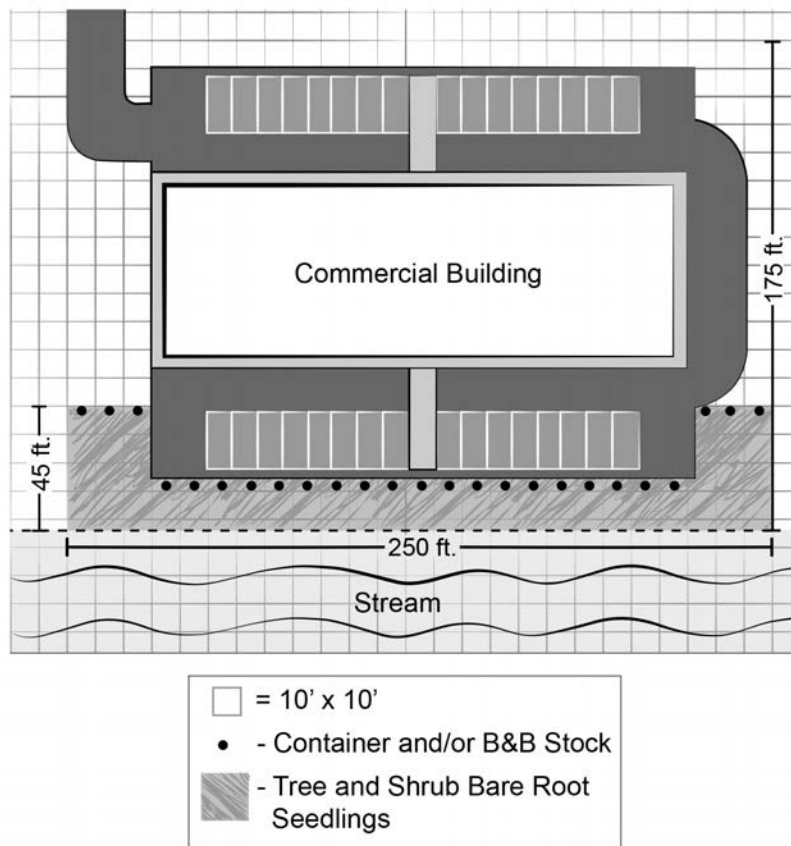

Figure 17a. Planting sketch of one-acre commercial lot: Buffer with bare root seedlings and visual screen of container/B&B trees and shrubs

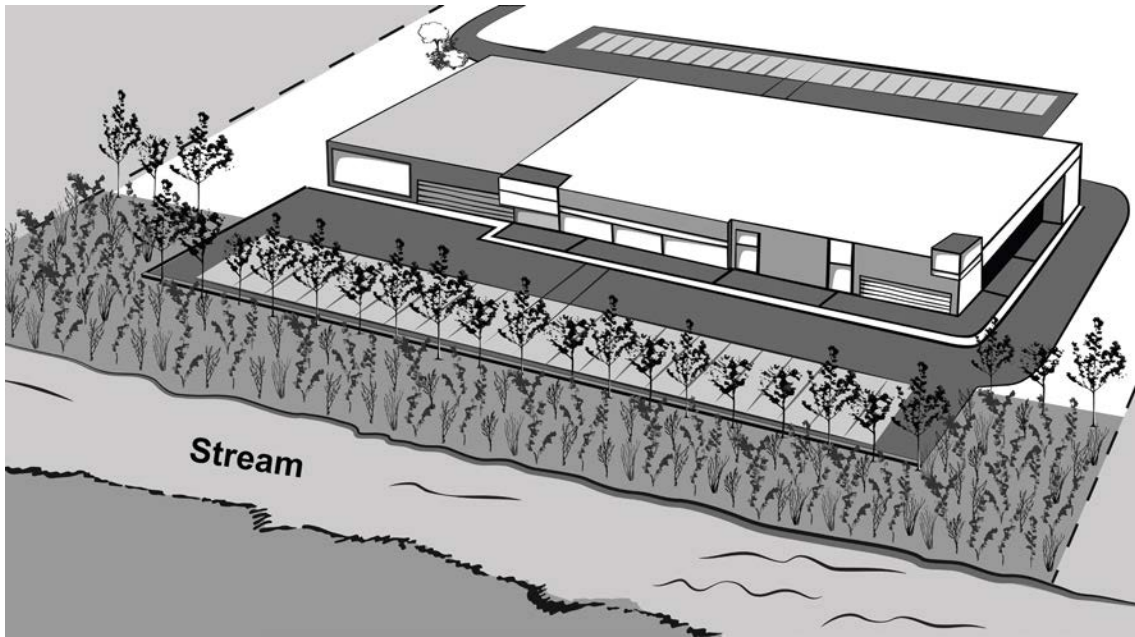

Figure 17b. One-acre commercial lot: Buffer with bare root seedlings and visual screen of container/B&B stock just after planting

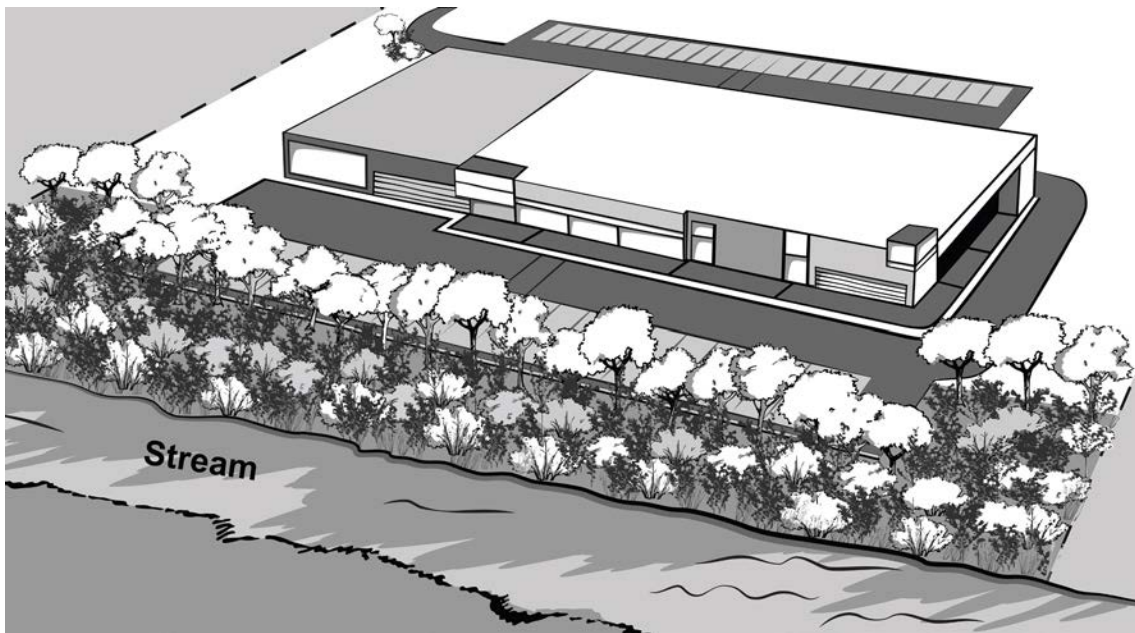

Figure 17c. One-acre commercial lot: Buffer with bare root seedlings and visual screen of container/B&B stock showing five years of growth

Buffer Planting Using Only Container and B&B Stock

There are circumstances that sometimes warrant installing a riparian buffer using larger plant stock with a maintenance regime that includes mowing. This may be the case on public properties such as at schools or parks where sight lines must be maintained. A property owner may also live in a subdivision with association covenants that allow only certain types of landscaping. Before taking this approach, it is important to check with the local municipal engineering and/or stormwater program to ensure that mowing a buffer is not counter to any local riparian ordinances.

The installation of a buffer using solely container and/or B&B plant stock can be very costly, with most native shrub prices ranging from \$25 to \$50 and trees from \$50 to \$125 each. With this investment, it is particularly important that the plants are installed and maintained correctly. A general rule of thumb for planting distances between container and/or B&B plant stock is 10 ft (10x10=100 ft²) per tree/shrub. A more species-specific riparian landscape design may be created with the assistance of a landscape designer. The native riparian plant list in Appendix D can be provided to your landscaper as your preferred plant selections to ensure the most appropriate plant species are installed. It is also important that no grading of waterway banks be done. This first requires a TDEC Aquatic Resource Alteration permit, <http://www.tennessee.gov/environment/article/permit-aquatic-resource-alteration-permit>.

Three-Quarter Acre "Open Space"/Park Lot

Plan: In the following park setting, there will be a walking path and a canoe access path, with the former being five feet wide and the latter 10 ft wide, reducing the total planting space by 675 ft².

Total Buffer Area = 45 X 180 ft = 8100 ft²

Walking Path = 45 ft X 5 ft = 225 ft²

Canoe Access = 45 ft X 10 ft = 450 ft²

Total Planting Area = 8100 ft² - 675 ft² = 7425 ft²

of Container and/or B&B Plants = 7425 ft²/ 100 ft² = 74

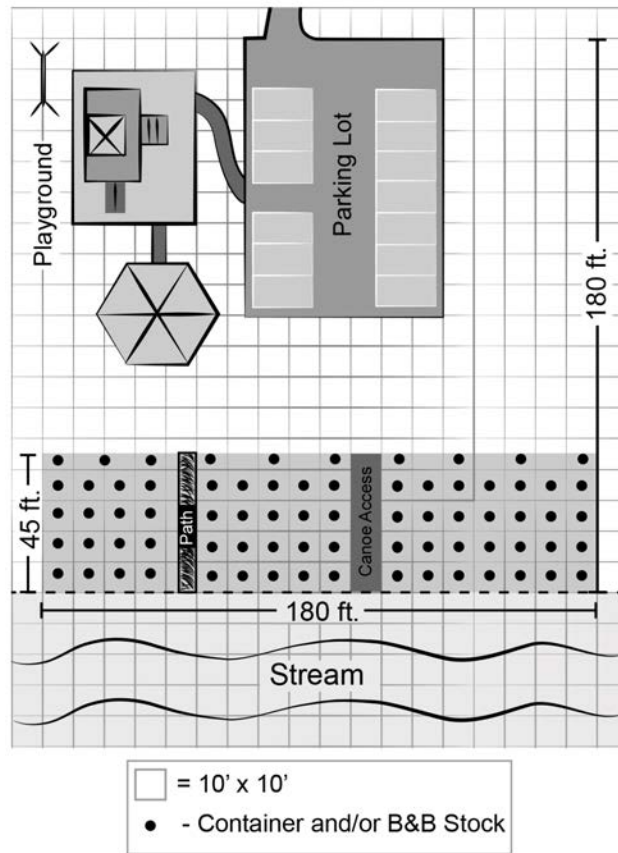

Figure 18a. Planting sketch of three-quarter acre park lot: Buffer with only container/B&B stock

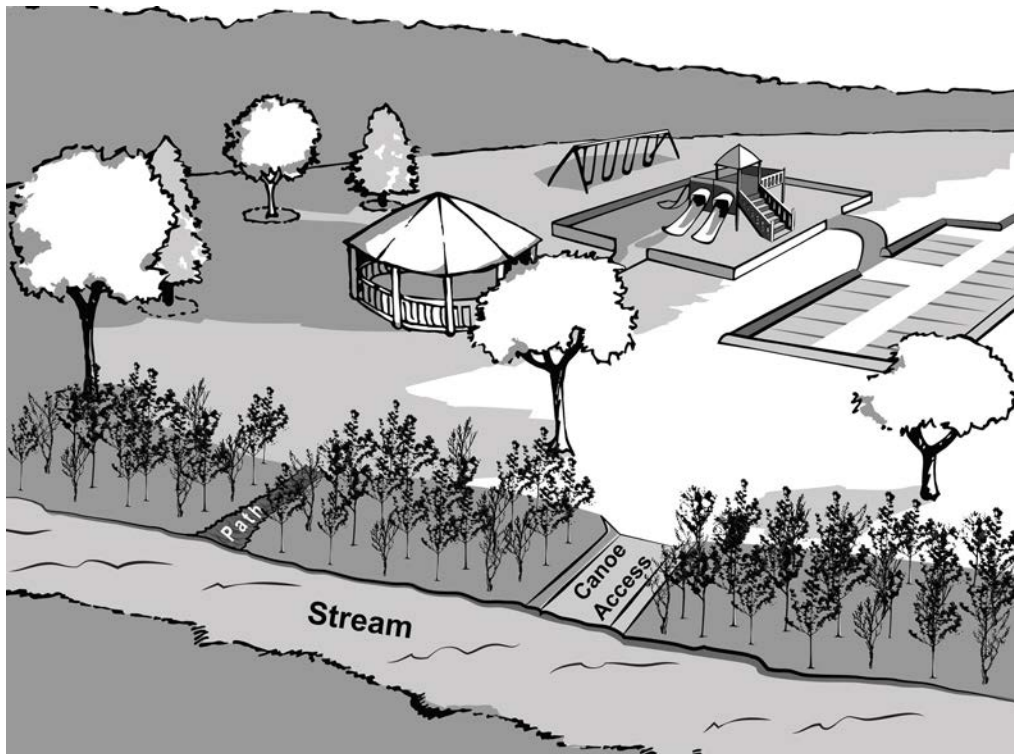

Figure 18b. Three-quarter acre park lot: Buffer with only container/B&B stock just after planting

Selecting tree and shrub species

Several factors should be considered when selecting plants for a buffer area. The native plant list in **Appendix D** can be used as an initial guide along with the Handbook's **Supplementary Resources** section. When it comes to selecting the number and mix of plant species for your buffer, there is no one set formula, but there are some plant selection considerations that can be followed:

Native Plants

First and foremost, it is recommended that native plants be used. They have adapted over a long period of time to regional conditions and are generally much hardier. They have also co-evolved with native wildlife, developing mutually supporting ecological relationships.

It can be useful to take note of native plants in nearby riparian areas, particularly any areas that have been protected from development. These can offer insight into native plant communities common to that area and can be used as a guide in re-establishing a plant assemblage. If plant identification and native plant communities are new to you, contact your county Extension office, nature center or state TDF or local Urban Forestry Staff for assistance.

Native Plant Sources

Go to [http://picktnproducts.org/Plants/Native Plants](http://picktnproducts.org/Plants/Native%20Plants)



We can all help to expand the supply of native plants by requesting them at local plant nurseries!

Plant Form

The structure of the plant is important to consider. It is generally best to use a mix of canopy, subcanopy, and shrub species to create a highly functional buffer—one that will shade the waterway, protect against bank erosion and provide wildlife habitat. When visual access to a waterway is desired, plants with a more open structure or those that are lower growing can be used.

Preferred Growing Conditions

Most plants will survive under a wide range of growing conditions, but have a preferred set of conditions for peak performance. The native plant list (see Appendix D) contains soil moisture, light requirements and pH preferences for many of the plants. The buffer installation approach of installing all seedlings at one time does place some plants at a temporary disadvantage. For example, the subcanopy trees prefer at least partial shade. However, most will grow with full

sun conditions, with their performance improving as the taller growing canopy tree species obtain a height to create shade conditions. In addition, if the area is not mowed, some shade may be provided by taller growing “volunteer” herbaceous plants (a.k.a. weeds).

Wildlife Value and Aesthetics

Other considerations when selecting plants can include the plants’ production of fruits, seeds, and/or nectar that is used as food for wildlife. For example, the Spicebush swallowtail larvae feed on plants in the Laurel Family, with spice bush (*Lindera benzoin*) being one of the most common. Plants can also offer year-around beauty from their berries and bark to leaf colors. Consider the brilliant red maple leaves or white bark of a sycamore against a fall blue sky or the clusters of red berries wrapped around the winterberry on a cold snowy winter day.

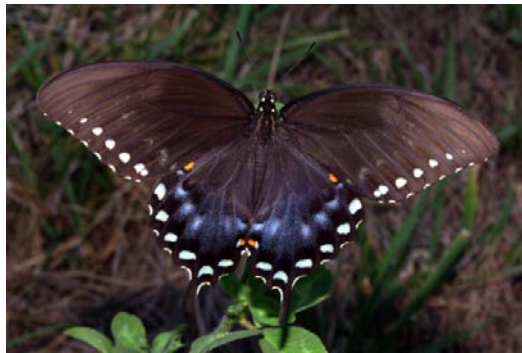

Figure 19. Spicebush Swallowtail Butterfly, *Papilio troilus*
Photo Credit: © 2008 HaarFager at [en.wikipedia GFDL \(http://www.gnu.org/copyleft/fdl.html\)](http://www.gnu.org/copyleft/fdl.html).

Number and Mix of Plant Species

In determining the number and mix of plant species, no one species should dominate and there should be enough species that if one or two species do not make it, a healthy buffer stand will remain. Consider the following guidelines to help achieve these objectives:

- No one species should comprise more than 20% of the mix of species.
- Include a mix of canopy, subcanopy and shrub species, with about 60% of the total plant count being canopy trees.

Another factor that needs to be considered when purchasing bare root seedlings is that most nurseries provide them in multiples of 25 or 100. If extra plants are purchased as a result, consider overplanting the buffer site or using them as give-a-ways.

Example of Buffer Plant Mix

In the prior half-acre residential lot example that incorporates a window and path into the buffer about 180 bare root seedlings are required, with about 40 being relatively low growing shrubs for the window. Table 3 provides a mix of plants for this site. The numbers take into account that the seedlings will be purchased in bundles of 25. In addition, a mix of 11 available container and/or B&B trees and shrubs of the same species (e.g. red maple, tulip poplar, wild hydrangea) could be purchased for the buffer's edge that would create a visual screen.

Table 3. Number of Bare Root Seedlings and Shrubs Needed

Canopy	#	Subcanopy	#	Shrubs	#	Total
Willow oak	25	Red mulberry	25	Wild hydrangea	25	75
Shumard oak	25			Hearts-a-bustin	25	50
Tulip poplar	25					25
Red maple	25					25
Sweetgum	25					25
Total	125		25		50	200

Preparing a Site for Buffer Installation

Prior to the installation of a buffer the site will need to be prepared. This section contains critical steps to ensure the community planting is conducted safely and that the plants can be installed according to plan, without the hindrance of unwanted debris and plants. This includes the removal of nonnative invasive plants that is further described in **Appendix E**.

Call Tennessee811 Before Digging









The state of Tennessee requires that any landowner who digs on their property first contact Tennessee811 to have all underground utilities marked. This is done by calling 811 or submitting an e-request at www.tnonecall.com. Prior to the call, clearly mark the outline of the proposed buffer area to be planted with white flags, paint or stakes.

TN One-Call website, <http://www.tnonecall.com>, contains a full description of this service.

Key points include:

- The call must be made at least three business days prior to beginning digging; however, it is advisable to call as much as a week in advance to ensure that the area is actually marked before planting begins.
- You will be provided a ticket number with a start date and time on it. The ticket is good for 15 days. That is, you are only allowed to dig during those 15 days.
- The utility companies will mark utilities using a required color coding system and will be identified by paint, stakes or flags.
- If any digging extends beyond the 15 days, you have to call 811 to obtain an extension on the ticket time.
- It is important to explain to children that the flags are not to be removed.
- Avoid digging within 24 inches on either side of the markings, or 10 feet within either side of water or sewer lines. Check with your local utilities for additional digging stipulations adjacent to lines.

Table 4. Spray Colors Used by Tennessee811 to Depict Type of Underground Utilities

APWA Uniform Color Code for marking underground utility lines.		
COLOR		Utility Line
WHITE		Proposed Excavation
PINK		Temporary Survey Markings
RED		Electrical Power Lines, Cables, conduit and Lighting Cables
YELLOW		Gas, Oil, Steam, Petroleum or Gaseous Materials
ORANGE		Communication, Alarm or Signal Lines, Cables or Conduit
BLUE		Potable Water
PURPLE		Reclaimed Water, Irrigation and Slurry Lines
GREEN		Sewer and Drain Lines

Other tasks that may be required before planting include:

- **Removing excess debris** like logs, branches or trash
- **Mowing herbaceous materials** that are one foot or higher to make it easier to plant and to reduce initial competition for the bare root seedlings. It may be necessary to use a brush hog if the vegetation is particularly dense. Clearly mark any vegetation, shrubs or trees that are NOT to be mowed.
- **Removing invasive plants.** Certain nonnative plants like bush honeysuckle, Chinese privet and multiflora rose, are often highly invasive in riparian areas and may need to be removed to allow for planting. A plant specialist can help in identifying those plants that should be removed from the site as opposed to just being mowed.

Approaches to Removing Invasive Plants

There are a range of control methods for invasive species, but care should be taken when selecting one to ensure it is appropriate for the targeted plant species. The Nature Conservancy has an online “weed control” handbook that offers a wealth of information on the general approaches that can be taken for invasive removal, <http://www.invasive.org/gist/handbook.html>. Additional resources on general and invasive plant-specific removal strategies can be found in the Supplementary Resources section. Two commonly used invasive plant removal methods are manual or mechanical control and cut/stump herbicide treatment.

Manual or Mechanical Control: Manual or mechanical control can include hand pulling or using a pulling-tool such as a Weed Wrench™.

- Hand pulling can be effective on some young shrubs and tree saplings, but care should be taken not to break off the stem and leave root fragments that can resprout.
- A Weed Wrench™ has a specialized claw to grip the stem and provides a lever to pull the plant up and out. There are varying sizes of weed wrenches based on the stem size. The challenge with using weed wrenches in riparian areas is that they work best on firm ground and not soft substrate as is often the case in these areas. Weed Wrenches are no longer being manufactured but used ones are available online and similar alternatives are now on the market. Local municipal departments or Extension offices may have them available for loan.

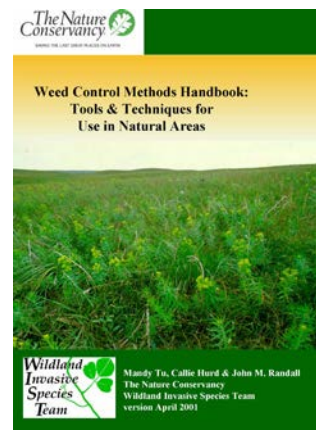

Figure 20. The Nature Conservancy's *Weed Control Methods Handbook*



Figure 21. Weed Wrench™

It is important to not mechanically remove plants immediately adjacent to a waterway when the plants' root systems are serving to stabilize the waterway's bank. In situations like this, it may be necessary to keep the plant pruned back until the installed natives have matured enough to provide the needed bank stability.

Cut Stump Herbicide Treatment: This method involves cutting the plants' stems and applying an herbicide to each stem by spraying or painting the stems' end.

The appropriate herbicide must be selected. For example, with Chinese privet, a 25% concentrate of glyphosphate may be used. As with all herbicide applications, all application directions should be strictly followed.

The best time to apply an herbicide is determined by the physiology of the plant, so it is important to reference plant-specific guidelines. A dye may be mixed with the herbicide to ensure the herbicide is being appropriately placed and to easily see which plants have been treated. The Nature Conservancy's Weed Control Handbook provides directions on how to make an inexpensive PVC herbicide applicator. It is also shown in **Appendix E**.



Figure 22. Application of herbicide with dye to tree stump

This page intentionally left blank

Properly Installing Plants

A common adage among gardeners is “for a dime-size plant, dig a dollar-size hole.” One of the most important elements in training volunteers is on how to properly handle and install the plants. This training should include a planting demonstration. You may also want to provide volunteers with the recommended plant installation approach in advance of the planting. **Appendix F** contains a handout on proper planting procedures.

Bare Root Seedlings

- Keep roots damp, cool and out of the sun until ready to be planted.
- One to three hours prior to planting, remove seedlings from their shipping bags and place in buckets of water to hydrate the roots. Keep out of the direct sun.
- At the seedling planting site, remove about a two-foot diameter circle of vegetation with a shovel or mattock. Consider composting this removed green waste or simply set it aside.
- Dig the hole two feet wide and deep enough for roots to remain straight.
- If a hole cannot be dug two feet deep, dig a horizontal trench out from the planting hole deep enough to bury long roots.
- Set aside excavated soil for backfill. It may be helpful, especially in areas of higher dense turf, to place the excavated soil into a five-gallon bucket so that it is not lost into the vegetation or turf.

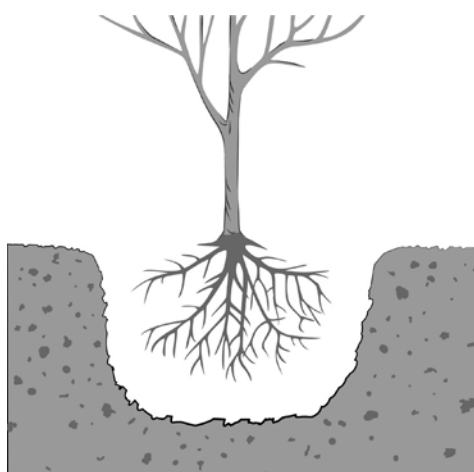

Figure 23. Bare root seedling in 2-ft diameter hole

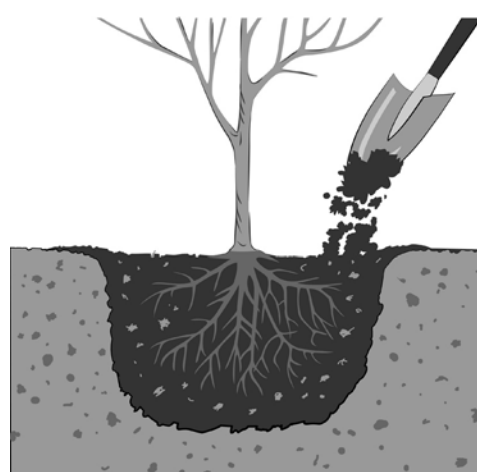

Figure 24. Bare root seedling planted in hole with backfill soil being tamped down

- Set seedling in hole, ensuring it is straight and that the slightly swollen area just above where the roots begin (root flare) is about level with surface.
- While holding the seedling erect, backfill the hole using the excavated soil, being sure there are no exposed roots. Do not replace the excavated turf back around or near the seedling.
- Lightly tamp soil to eliminate air pockets, but do not compact the soil.

Container-Grown or Balled and Burlapped (B&B) Plants

- Protect plants from wind damage in transport to the planting site.
- Keep plants well watered until ready to plant.
- Dig hole twice the width of the container or root ball with sloping or flared sides wider at the top than at the bottom.
- Set container or B&B plant into hole to see if it is the right width and depth before removing the container or burlap. Adjust hole size as needed.
- **Container-grown:** Remove plant from container. If roots are “root bound” (e.g., roots wound tightly around the outside of the soil ball), tease or prune the roots loose. Place root ball in hole, spreading roots out.
- **Balled and burlapped (B&B):** Place trees in hole. Remove wires or string folding the burlap down the sides of the ball to the bottom of the hole. Burlap may be removed completely if it can be done without disturbing the root ball.
- Position the tree so the root flare is at or just above the ground level and be sure that all roots will be buried when hole is backfilled.
- Backfill with soil, making sure trunk is straight. Do not use soil amendments.
- Tamp soil to eliminate air pockets.

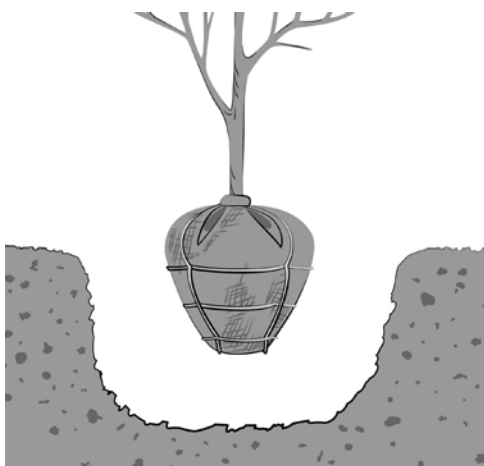

Figure 25. Dig hole that is twice the width of the root ball of a container/ B&B plant



Figure 26. Place B&B plant into hole and backfill with soil

- Apply three to four inch depth of mulch around the tree, keeping the mulch several inches away from the trunk. Figure 28 shows mulch mounded high against trunks (a.k.a. ‘volcano mulching’) which can promote disease.
- Stake large trees in windy areas. Remove staking after one year.
- Water, as needed, particularly through first growing season.

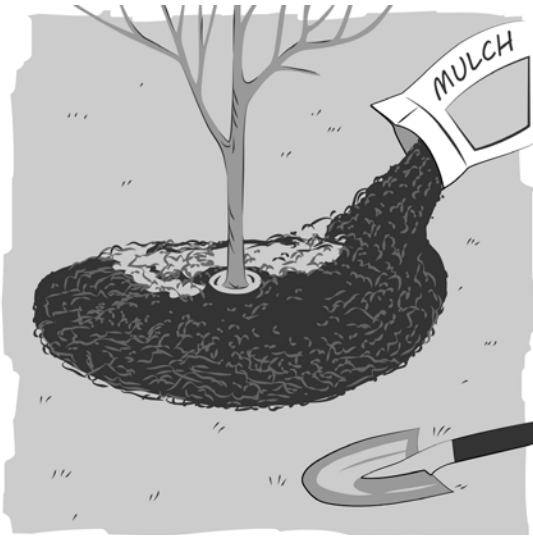

Figure 27. Mulch application around newly planted tree



Figure 28. Example of “volcano mulching”

Table 5. Plant Water Needs

Most plants ideally need about one inch of water per week. This table converts this amount into gallons per week based on the spread of the tree or shrub.

Water Amount (gallons/week)	Canopy Spread (feet)
0.5	1
2.0	2
4.5	3
8.0	4
12.0	5
18.0	6

During hot weather these amounts may double.

This page intentionally left blank

Organizing and Conducting a Riparian Buffer Planting

Conducting community planting days can be great fun and rewarding as volunteers come together for the camaraderie and to make a difference in their community. The planning process can also be fruitful as partnerships are built and resources are shared. However, there are always many details that need to be addressed to ensure a successful event. This section provides a step-by-step guide for organizing and conducting a community planting. It can also be used as an initial planning framework and perhaps provide insights on considerations that otherwise might have been overlooked. It is not one-size-fits all and will need to be adapted to the needs of your community and partners. This guide is also provided in a handout format in **Appendix G**.

1. Consider potential project partners who can assist in identifying potential planting sites and provide resources (e.g., plant knowledge; loan tools).

These may include your local municipal stormwater program, County Extension office, NRCS district office, or local watershed group.

2. Conduct an initial partner planning meeting to discuss:

- project goals (individual and mutual) and timeframe;
- candidate planting sites;
- potential sources of project funding if not already secured (A project may have to be delayed up to a year if grant funds are being sought.);
- and a date to conduct a field outing to assess potential buffer sites.

3. Select your buffer site

- Conduct a “windshield survey” in your community, looking for riparian areas devoid of vegetation. Consider using on-line maps (e.g., Google Earth) to help.
- Identify the property owners of potential planting sites and discuss with each their interest in participating in a planting project and willingness to protect if planted.
- Obtain landowner’s approval to go onsite to conduct the initial buffer prioritization assessment in order to rank and select a site (see Appendix B).

4. Create a buffer plan (See Appendix C)

- Conduct a site inventory.
- Create a planting sketch including any features affecting the planting area size.
- Determine planting area quantities.
- Identify mix of desired plant species.

5. Check on sources of seedlings and B&B/container trees and shrubs

- Check cost, availability and shipping dates of bare root seedlings from on-line nurseries.
- Visit local nurseries and garden stores to find desired B&B/container trees and shrubs. This should be done far enough in advance (e.g., one month) to ensure desired stock can be found. Often nurseries and garden stores will let you purchase in advance and will hold the stock, particularly if it is for a community planting event.

6. Select a tentative planting date at least three months in advance

- Best time of year for planting container or B&B plants is from November through March, and for bare root seedlings is January through March when they are in dormancy.
- Check calendars to ensure that other events will not conflict with your targeted volunteer source.
- Identify a rain date.

7. Identify number of volunteers and supervisors needed for planting. Consider:

- the number of plants to be installed and the length of planting event.
- supervisor to volunteer ratio—typically one supervisor to 10 volunteers.

Table 6. Estimated Number of Volunteers Needed for Planting Bare Root Seedlings

# of Volunteers or Volunteer Teams	Bare Root Seedlings Installed	
	Per Hour	Per 3 Hours
10	60	180
15	90	270
30	180	540

8. Develop a draft volunteer recruitment strategy

- Consider key groups for obtaining volunteers—scouts, watershed and conservation groups, civic groups, churches and home school networks—and whether the event will be promoted community wide.
- Identify the most effective ways of reaching candidate volunteers
 - » Websites

- » Social media
 - » On-line community calendars
 - » Listserves
 - » Flyers (See example in Appendix F)
- Identify the event's contact person who can answer event questions and interact with the media.
 - Determine if pre-registration for the event is required and how registration will be conducted (via e-mail, telephone or on-line registration).
 - Provide volunteer expectations (e.g., bring shovel) in marketing materials or in a follow up participation confirmation call or e-mail.
 - Consider making a real-estate size sign that promotes the upcoming planting and place it at the planting site location two weeks in advance. This will also notify the adjacent landowners of the pending planting installation (See example in Appendix F).

9. Conduct partner planning meeting

- Finalize planting date.
- Discuss draft volunteer recruitment strategies given needed number of volunteers. Seek input and contributions each partner can make.
- Discuss needed supplies and potential sources.
- Finalize planting plan budget including costs of plants, materials for recruiting volunteers and day-of-event supplies. Often when multiple partners are involved in project, costs can be shared and item/services can be donated (e.g. copying of flyers).

10. Order plants

- For bare root seedlings, order early in nursery's shipping period to ensure availability.
- Ask for delivery the week before planting. Nurseries typically dig the seedling right before packaging for shipping.
- Call two weeks before delivery to ensure nursery confirms delivery date.

11. Implement volunteer recruitment strategy

12. Prepare the site for buffer installation

- Call Tennessee811 a week before site preparation day to ensure utility lines are marked.
- Mark site boundaries with **WHITE** flagging, paint or stakes.

- Locate and remove debris (washed up trash, branches).
- Mark any areas of safety concern (e.g., using flags mark holes in ground).
- Remove any unwanted invasive plants.
- Mow if area is covered in tall (one foot or greater) herbaceous plants, being careful to not mow any vegetation, shrubs, or trees that are to be retained.
- Dig several test holes to determine how hard ground is for installing plants. This may affect number of volunteers needed and/or length of planting event.
- Consider parking and bathroom (portable toilets or nearby facility) accommodations for volunteers.

13. Prepare supplies.

- Buckets
 - » Estimate one five-gallon bucket per 50 to 100 seedlings. The seedlings should be in buckets of water one to three hours before volunteers arrive to ensure they are well hydrated.
 - » Municipal partners (parks, public works) may have these for loan or ask subset of volunteers/supervisors to bring.
- Shovels
 - » Provide one shovel per volunteer. If volunteers are asked to bring their own shovels, still have on hand at least half the required number.
 - » Consider asking municipal partners if they have shovels to loan.
- Mulch
 - » Check with the municipal park or solid waste department for free mulch or ground up yard waste.
 - » Mulch to a depth of three inches around B&B and container plants, ensuring the mulch does not touch the trunk.
 - » Determine mulch needs:
 - ◇ A three-foot diameter mulched area with a depth of three inches requires 1.75 ft³ of mulch.
 - ◇ A cubic yard equals 27 cubic feet
 - ◇ Most scoops at nurseries are three-quarters of a cubic yard (ask about scoop size).



Figure 29. Shovels and buckets laid out for volunteers

Table 7. Required Mulch Amounts

# of Trees/Shrubs (3-ft diameter around plant)	Cubic Yards (yd ³)	Scoops (0.75 yd ³)
10	0.65	~1
20	1.30	~2
30	2.60	~3

- Gloves - Check with your municipality's solid waste department or Keep America Beautiful affiliate for a donation of gloves or ask volunteers to bring them.
- Registration Area
 - » Tent: Consider setting up a pop-up canopy where volunteers can register and supplies can be kept. It will provide a central operating point, bringing more organization to the event.
 - » Table, chair(s), registration materials, clip boards
 - » Nametags can help to create rapport by addressing individuals by name when assisting with instruction and planting
- Snacks
 - » Use coolers for water to avoid bottled water waste. Ask volunteers to bring their own water bottle but have recyclable cups available.
 - » Carbohydrate/protein source (e.g., peanut butter crackers, cereal bars, fruit) should be available for those who may have blood sugar conditions.
 - » Sponsoring organizations may want to have event-end "celebration" snack for volunteers.
- Other
 - » First aid kit
 - » Sunscreen, bug spray (if needed)

14. Day of event actions

- Have all supplies on site and organized prior to volunteers arriving.
- Sign-in volunteers
 - » A liability form may need to be completed if participating organizations and/or landowner deems it necessary. Youth volunteers may require a parent or guardian signature on the waiver (see Appendix F).
 - » Some volunteers may require verification of their service hours for clubs or classes. Have pre-made forms that volunteers can take to verify service hours.

- Conduct volunteer training
 - » Recognize partners, donors, and cooperating property owners.
 - » Introduce intent of buffer – functions and benefits (see Appendix A).
 - » Review safety considerations.
 - » Demonstrate how to properly install plants with a large group. It may be necessary to break into smaller groups so that all can easily see demonstration and ask questions.
- Consider establishing a planting “quality control” system for younger volunteers. For example, once a hole is dug, have volunteer raise their hand so supervisor can assess hole size. If not working in pairs, have supervisor hold tree upright as volunteer backfills soil into hole.
- Install plants.
- Water container and B&B plants if ground is dry. No watering is required for bare root seedlings if planted during dormancy months.
- Mulch container and B&B plants to approximately a three-inch depth and a three-foot circumference. **Avoid mulch touching stems.**
- Do final walk through of site to ensure all plants have been properly installed and that all tools and trash has been collected.
- Gather volunteers for a final thank-you and a group photo. May want to consider a final treat or gift for all to enjoy together as a thank-you.
- Take before and after pictures of the site from a fixed photo point to document changes to the site over time.
- Take a group picture of the volunteers, and of them planting, to share later via social media, websites, etc., as well as to publicize the event.



Figure 30. Volunteers planting bare root seedlings during dormancy months.

Table 8. Buffer Planting Project Sample Time Line	
2015	
September	<ul style="list-style-type: none"> • Conduct preliminary partner meeting
October	<ul style="list-style-type: none"> • Conduct “windshield survey” of potential buffer sites • Contact landowners to discuss planting project feasibility (i.e., Is the landowner supportive of the riparian planting and willing to ensure that the riparian buffer will be protected?) • Rate and rank potential buffer sites; select buffer site
November	<ul style="list-style-type: none"> • Work with landowner on planting plan • Set a planting date
December	<ul style="list-style-type: none"> • Order seedlings (ask for delivery one week before planting)
2016	
January	<ul style="list-style-type: none"> • Scout out sources of container/B&B stock if needed • Identify number of volunteers/supervisors needed & develop volunteer recruitment strategy • Conduct partner meeting to: review planting plan; discuss volunteer recruitment; who can help with prep day; supply list (who can bring what) • Last two weeks of January begin volunteer recruitment • Install yard sign at site advertising the event and notify neighbors.
February	<ul style="list-style-type: none"> • By first week, order container/B&B plants • Feb. 1 - Call Tennessee811 • Feb. 6 - Site Preparation Day - Remove invasives, trash...
February 13	BUFFER INSTALLATION EVENT
February 20	Rain Date (call to extend 811 ticket if rain date must be used)

This page intentionally left blank

Maintaining and Protecting Your Buffer

The installation of a buffer provides great satisfaction in knowing that an important step has been taken to protect a waterway. However, a buffer's effectiveness ultimately lies in it being protected over time, allowing for the buffer plants to mature and their ecological functions to evolve. This section contains information on buffer protection strategies including pro-active steps that can be taken to increase community acceptance of the buffer during its early successional stages; educational signage for the public and maintenance crews; and vegetation management tips. A template sign is provided in **Appendix G**.

Informing Your Neighbors

It is advisable to contact adjacent landowners two weeks in advance to inform them of the actions being taken to establish a buffer and how the property's appearance will change over time. This can help to alleviate concerns neighbors may have over property neglect. Communication may be conducted through mailings, signage, or by going door-to-door. It is also an excellent opportunity to educate neighbors on the benefits of buffers, gain their buy-in, and invite them to participate in the planting!

Be prepared to encounter occasional opposition to the buffer. Some neighbors may express concern about the unkept look of the site, snakes, coyotes, mosquitos, and vagrant use of the site. Local greenway or stormwater coordinators most often address these concerns; it may be beneficial to seek their guidance on how they respond to them.

Managing Vegetation

Once a riparian buffer is planted, it is generally recommended not to mow. "Weeds" will soon begin to colonize around the seedlings and take on more of an unkept appearance. It is nature taking its course with early succession beginning. During this time it may be helpful to "maintain" the outer edge of the buffer, keeping vines and weeds from overtaking the edge trees and shrubs, and perhaps planting or sowing native wildflowers along the buffer edge. The site appearance

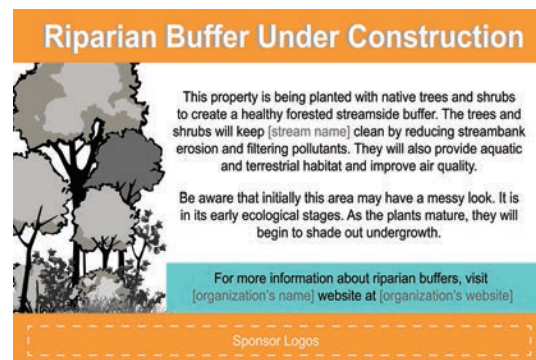

Figure 31. Example of signage for notifying and educating neighbors about buffer installation

may gain appeal with the recognition that the area will take less maintenance. It can also be quite interesting to observe plants patterns, identifying volunteer plants that colonize and competition among species. Local school groups might use it to study ecological principles in action and wildlife enthusiasts will likely find the area attracting a greater abundance and diversity of birds.

- Physical Access

Any paths installed to the waterway will need to be periodically mowed or brushcut to keep the path open. Consider mowing to a height no less than four to six inches.

- Visual Access

Low-growing or open structure shrubs may be installed to create “windows” to the waterway. It is inevitable that outside seed sources will migrate in by wind or animals and that periodic removal of unwanted species will be required. By walking these areas once or twice a year, newly germinated seedlings can be identified and easily removed.

Removing Invasive Plants

Nonnative, invasive plants commonly colonize riparian areas and can crowd out installed plants if not removed. It is recommended to walk the buffer area twice a year to look for unwanted plants. Consider walking on an imaginary grid to ensure the entire area is covered. When identified young, many of the invasive plants can be pulled up at the base of the stem by hand. For more information on invasive plant removal see **Appendix E**.

Long-Term Protection

Depending on the location of the installed buffer, it may be necessary to mount several signs along the outer edge of the planted area that indicate it is a “no mow zone” (Figure 32). If the area has traditionally been mowed, it may be necessary to install temporary fencing (Figure 33) to reinforce this message. An additional benefit of installing “no mow” signs is that it provides an opportunity to educate the public about the buffer functions and can also include such information as a municipality’s water quality hot line number.

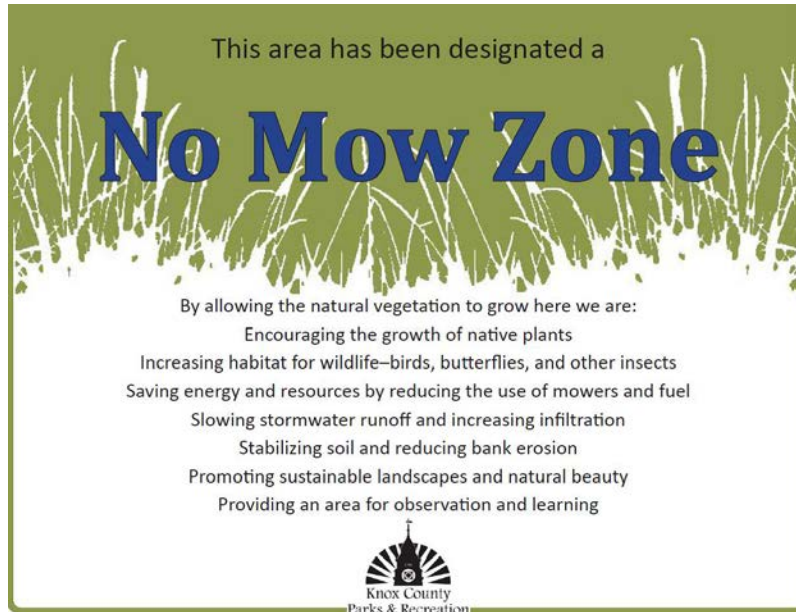

Figure 32. Example of a “No Mow Zone” sign that also educates passers by



Figure 33. Temporary fencing to protect newly installed seedlings at South Doyle Middle School on Baker Creek, Knoxville, TN



Figure 34. Buffer site before planting



Figure 35. Buffer site just planted with B&B/ container edge trees and bare root seedlings



Figure 36. Buffer site 1.25 years after planting

Glossary

Aquatic – Of or pertaining to water; within the waterway

Balled and Burlapped (B&B) Plants – A method used to transplant more mature shrubs and trees from production fields for retail and commercial sale. The plant's roots remain covered by a ball of soil that is then wrapped in burlap and tied with wire or twine and often pinned together with nails or staples.

Bare Root Seedlings – A method used to transplant very young trees and shrubs (generally less than two years old) from production fields. The plants are dug in dormancy; no soil is retained on the roots; and the roots must be kept moist for the plant to survive.

Buffer – See “riparian buffer”

Canopy – The upper layer of trees in a forest or forested buffer

Clean Water Act – A 1972 federal act that provides the basic regulatory framework for the protection of water quality through control of discharge of pollutants into surface waters, including the management of stormwater runoff. Public Law 92-500.

Container/Containerized Plants – A method used to raise trees and shrubs for sale where the plants have been grown generally for a year or more in a container.

Ecological Succession – The gradual change in a plant community brought about by the progressive replacement of one combination of plants with another until a stable mature community is established.

Edge Effect – An ecological term that refers to the conditions that occur at the boundary of two habitats such as at the border of a riparian buffer and residential lawns. These conditions can be influenced by physical factors such as light as well as biological factors such as species composition and predator/prey relationships.

Erosion – The detachment and transport of soil or rock due to physical movement of water or air or other chemical or biological means.

Floodplain – The flat area along a stream between the streambank and the valley wall that is periodically inundated by floodwaters.

Habitat – A geographical unit that supports an interconnected community of plant and animal organisms that includes the abiotic elements such as soil, temperature, sunlight.

Infiltration – The movement of water into soils.

Invasive Plants – Plants that are generally introduced outside a particular region that outcompete native plants, resulting in environmental and often economic harm to a community.

Native Plants – Plants that naturally occur in a region or habitat and have co-evolved over geologic time with other plants and animals to develop specialized ecological relationships. They serve vital ecological roles, creating a balanced plant community that supports indigenous wildlife.

Nonnative Plants – Plants that are not native to a region and are often introduced as ornamentals for landscaping purposes or to address land use impacts such as erosion. Not all nonnative plants are invasive; however select ones have become so (e.g., kudzu), outcompeting native plants.

Nutrients – Compounds that are needed for growth of organisms and can be carried in excess quantities by stormwater runoff from over-fertilized areas to waterbodies. Excess nutrients in waterbodies can result in harmfully low oxygen levels. Major nutrients include nitrogen, phosphorus, and potassium.

Pathogen – An organism that causes disease.

Pollutant – A contaminant in a concentration or amount that adversely alters the physical, chemical, or biological properties of the natural environment.

Riparian Buffer – A riparian buffer is the transitional area between land and water that contains a mix of trees, shrubs, grasses and wildflowers. This vegetated strip of land “buffers” the waterbody from human impacts such as residential development and agricultural activities and is a primary defense in the protection of our waterways.

Sediment – Eroded rock and soil material that has been moved and subsequently deposited. Material generated by weathering or erosion that has been transported by wind, water, or gravity.

Siltation – 1) The accumulation or deposition of sediment. 2) A surface water pollutant comprised of silt and clay particles with excesses resulting in aquatic habitat degradation.

Stormwater Runoff – The rainfall that is shed by the landscape to a receiving waterbody when rainfall exceeds the infiltration capacity of the land.

Subcanopy – The lower canopy or lower layer of trees, shrubs and herbaceous plants within a forest or forested buffer

Understory – The subcanopy layer of a forest or forested buffer that consists of trees and shrubs that require less light.

Volcano Mulching – A harmful method of mulching where mulch is stacked against a plant, often resulting in diseased trunks.

Acronyms

HOA – Home Owners Association

NRCS – Natural Resources Conservation Service

TEC – Tennessee Environmental Council

TDA – Tennessee Department of Agriculture

TDF – Tennessee Division of Forestry

TDEC – Tennessee Department of Environment and Conservation

TNWRRC – Tennessee Water Resources Research Center

TVA – Tennessee Valley Authority

USEPA – United States Environmental Protection Agency

This page intentionally left blank

Supplementary Resources

Riparian Buffer

- Bentrup, G. 2008. Conservation Buffers—Design guidelines for buffers, corridors, and greenways. Gen. Tech. Rep. SRS-109. Asheville, NC: U.S. Department of Agriculture, Forest Service, Southern Research Station. 110 p. <http://www.srs.fs.usda.gov/pubs/33522/>
- Connecticut River Joint Commissions. 1998. Urban Buffers for the Connecticut River Watershed, Fact Sheet No. 6. <http://www.crjc.org/buffers/Urban%20Buffers.pdf>
- Forested Buffers: The Key to Clean Streams. 2006. Chesapeake Bay Foundation. <http://www.stroudcenter.org/press/pnassumarychbayfdn06.pdf>
- Schueler, T. 2000. The Architecture of Urban Stream Buffers: The Practice of Watershed Protection. Center for Watershed Protection, Ellicott City, MD. Pages 225-233. http://www.cwp.org/online-watershed-library/search_form then under “Search a Document” type in keyword “architecture”
- Stroud Water Research Center Information Sheets on the Benefits of Streamside Buffers, <http://www.stroudcenter.org/education/communities/buffers/>
- Tennessee Division of Forestry Riparian Buffer Program, <http://tn.gov/agriculture/article/ag-forests-riparian-buffer>
- Tennessee Valley Authority (TVA) Riparian Restoration, <http://www.tva.gov/river/landandshore/stabilization/>
- Wise, David. 2007. Landowner Guide to Buffer Success: A comprehensive seasonal guide for your forested buffer project. Chesapeake Bay Foundation. <http://www.cbf.org/document.doc?id=257>

Identifying Native Plants

- Gardening with Native Plants: <http://www.gardeningwithnativeplants.com/>
- “PB1731 Identifying Oak Trees Native to Tennessee,” The University of Tennessee Agricultural Extension Service, PB1731-1M-8/06(Rep.) E12-4915-00-003-07 07-0037, http://trace.tennessee.edu/utk_agexfores/11
- “PB1756 The All Season Pocket Guide to Identifying Common Tennessee Trees,” The University of Tennessee Agricultural Extension Service, PB1756-5M-9/08 (Rep) R12-4910-098-004-09, http://trace.tennessee.edu/utk_agexfores/13

- “PB1810 Identifying Hickory and Walnut Trees Native to Tennessee Using BRFs,” David Mercker, Karen Keurs, David Buckley, and Brien Otsby, PB1810, http://trace.tennessee.edu/utk_agexfores/115
- “SP 515 Native Trees for Tennessee,” The University of Tennessee Agricultural Extension Service, SP 515-15M-7/98 R12-4910-11-001-99, https://ag.tennessee.edu/tnyards/Documents/Native_Trees_for_Tennessee.pdf
- Tennessee Division of Forestry Resources, Map used to depict regions of Tennessee. <http://tn.gov/agriculture/topic/ag-forests-state-forests>
- TVA Using native plants to protect streambanks and shorelines in the Tennessee Valley, <http://www.tva.gov/river/landandshore/stabilization/using.htm>
- What Tree Is It? Provided by the Ohio Public Library Information Network, <http://www.oplin.org/tree/>

Site Preparation for Urban Riparian Buffer

- Tennessee811, <http://www.tnonecall.com>; Tennessee811 Brochure, <http://www.tenn811.com/Pages/homeowner%20brochure%20blue.pdf>

Invasive Plant Removal

- Tennessee Exotic Pest Plant Council (TN-EPPC): The TN-EPPC raises public awareness about the spread of invasive exotic plants into Tennessee’s natural areas, providing educational, advisory, and technical support on all aspects of invasive exotics. <http://www.tneppc.org>
- TN-EPPC Invasive Exotic Pest Plants in Tennessee, http://www.tneppc.org/invasive_plants
- Invasive Species Information for Tennessee: Provides links to state-specific resources with an interest in the prevention, control, or eradication of invasive species. <http://www.invasivespeciesinfo.gov/unitedstates/tn.shtml>
- Miller, James H.; Manning, Steven T.; Enloe, Stephen F. 2010, A Management Guide for Invasive Plants in Southern Forests. Gen. Tech. Rep. SRS-131. Asheville, NC: U.S. Department of Agriculture Forest Service, Southern Research Station. 120 p. A publication of the USDA Forest Service Southern Research Station that provides effective control prescriptions for 56 nonnative plants and groups currently invading the forests of the 13 Southern States. <http://www.srs.fs.usda.gov/pubs/36915>
- Miller, James H.; Chambliss, Erwin B.; Loewenstein, Nancy J. 2010. A Field Guide for the Identification of Invasive Plants in Southern Forests. Gen. Tech. Rep. SRS-119. Asheville, NC: U.S. Department of Agriculture, Forest Service, Southern Research Station. 126 p. A publication of the USDA Forest Service Southern Research Station that provides information on accurate identification of 56 plants or groups that are aggressively invading forests of the 13 Southern States. <http://www.srs.fs.usda.gov/pubs/35292>

- “PB1785-Invasive Weeds of the Appalachian Region,” The University of Tennessee Agricultural Extension Service, http://trace.tennessee.edu/utk_agexenvi/30
- “SP627 Identification and Control of Non-native Invasive Forest Plants in Tennessee,” The University of Tennessee Agricultural Extension Service, SP627-14M-9/04 R12-4910-045-001-05 05-0062, http://trace.tennessee.edu/utk_agexfores/75
- Tu, M., Hurd, C., & J.M. Randall, 2001. Weed Control Methods Handbook, The Nature Conservancy, <http://tncinvasives.ucdavis.edu>, Version: April 2001. <http://www.invasive.org/gist/handbook.html>
- Chinese Privet
 - » Control Options for Chinese Privet. Agronomy and Soils Series Timely Information Agriculture & Natural Resources. Alabama Cooperative Extension System. <http://www.aces.edu/anr/forages/Management/documents/controloptionschineseprivet.pdf>
 - » “W233 Privet,” The University of Tennessee Agricultural Extension Service, W233 09/09 10-0049, http://trace.tennessee.edu/utk_agexgard/68
 - » W 324 Pasture Weed Fact Sheet Chinese Privet The University of Tennessee Agricultural Extension Service, W 324 12/14 15-0110, <https://extension.tennessee.edu/publications/Documents/W324.pdf>
- Japanese Honeysuckle, Tennessee Exotic Pest Plant Council, http://www.tneppc.org/invasive_plants/127
- “W232 Mimosa,” The University of Tennessee Agricultural Extension Service, W232 09/09 10-0048, http://trace.tennessee.edu/utk_agexgard/67
- “W231 English Ivy,” The University of Tennessee Agricultural Extension Service, W231 09/09 10-0047, http://trace.tennessee.edu/utk_agexgard/66

Plant Selection for Your Urban Riparian Buffer

- A Landowner’s Guide to Native Warm Season Grasses in the Mid-South-UT Extension, <https://utextension.tennessee.edu/publications/Documents/PB1746.pdf>
- Native Plants for Tennessee. Tennessee Smart Yards. <https://tynnativeplants.wordpress.com>
- Native Tree Recommendations for Tennessee, <http://www.treesnashville.org/natives.html>
- “SP511 Plant the Right Tree in the Right Place,” The University of Tennessee Agricultural Extension Service, SP 511-15M-7/98 R12-4910-11-001-99, http://trace.tennessee.edu/utk_agexfores/46

- “SP512 Trees to Reconsider Before Planting,” The University of Tennessee Agricultural Extension Service, SP 512-15M-7/98 R12-4910-11-001-99, http://trace.tennessee.edu/utk_agexfores/47
- “SP530 Urban Trees for Wildlife,” The University of Tennessee Agricultural Extension Service, SP 530-15M-3/99 R12-4910-17-001-00, http://trace.tennessee.edu/utk_agexfores/53
- “SP533 Trees for Poorly Drained Soils in the Landscape,” The University of Tennessee Agricultural Extension Service, SP 533-15M-3/99 R12-4910-17-001-00, http://trace.tennessee.edu/utk_agexfores/55
- “SP570 Drought-Tolerant Trees,” The University of Tennessee Agricultural Extension Service, SP 570 -15M-12-00 R12-4910-21-002-01, http://trace.tennessee.edu/utk_agexfores/102
- “SP662 Guidelines for Buying Trees,” The University of Tennessee Agricultural Extension Service, SP662-15M-9/05 R12-4910-051-007-06 06-0076, http://trace.tennessee.edu/utk_agexfores/61
- TN-EPPC Landscaping with Native Plants: To promote the use of native plants in gardens and landscapes, TN-EPPC developed a set of three brochures in the 1990s, each designed specifically for East, Middle, and West Tennessee. These popular brochures were recently revised and consolidated into a single statewide document for easier use and wider application. The new version retains most of the original informative features including physiographic province details and comprehensive plant listings with culture specifications for woody species plus a greatly expanded selection of garden-worthy herbaceous perennials. <http://www.tneppc.org/pages/landscaping>
- Transmission Line Right-of-Way Compatible Trees and Shrubs-TVA, http://www.tva.gov/power/rightofway/trees_shrubs.htm
- TVA Native Plant Selector, <http://www.tva.gov/river/landandshore/stabilization/plantsearch.htm>

Tennessee Plant Nursery Resources

- Find Native Plants - Featured Tennessee Native Plant Resource, <http://findnativeplants.com/south/tennessee-native-plants/>
- Pick Tennessee Products - Native Plant Nursery or Nurseries, http://www.picktnproducts.org/Flowers_trees/index.html
- PlantNative: Dedicated to moving native plants and naturesscaping into mainstream landscaping practices. Lists native plant nurseries by state, <http://www.plantnative.org/>
- Tennessee Division of Forestry State Nursery, P.O. Box 59, Delano, TN 37325. Tel: 877.868.7337, The Division of Forestry's seedling nursery, located in Delano, TN, produces forest seedlings that are available for sale to landowners. These seedlings are adapted to growing conditions found in Tennessee and are used primarily for reforestation and forest conservation projects. <http://www.PlantTNTrees.org>

- Tennessee Nursery and Landscape Association Buyers Guide, <http://www.tnla.com/buyerguide.php>
- Tennessee Smart Yards - Native Plants for Tennessee: This list is for informational purposes only and is not intended to convey a recommendation for a specific source. <https://tynnativeplants.wordpress.com/buying-native-plants/>
- The Garden Watchdog at Dave's Garden website where over 7,600 mail-order gardening companies are listed, ranked and reviewed by customers. <http://davesgarden.com/products/gwd/>

Tree Planting Information

- How to Plant a Tree, <http://www.treehelp.com/how-to-plant-a-tree>
- "SP663 Tree Planting Procedure for Small, Bare-Root Seedlings," The University of Tennessee Agricultural Extension Service, SP663-1M-11/05 E12-4915-00-005-06 06-0096, http://trace.tennessee.edu/utk_agexfores/16

Maintenance Care

- "SP534 Nutrient Deficiencies in Trees," The University of Tennessee Agricultural Extension Service, SP 534-15M-3/99 R12-4910-17-001-00, http://trace.tennessee.edu/utk_agexfores/63
- "SP573 How to Recognize and Prevent Tree Hazards," The University of Tennessee Agricultural Extension, SP 573 -15M-12-00 R12-4910-21-005-01, http://trace.tennessee.edu/utk_agexfores/68
- "SP574 Post-Planting Tree Care - Fallacies and Recommendations," The University of Tennessee Agricultural Extension Service, SP574-15M-12-00 R12-4900-21-006-01, http://trace.tennessee.edu/utk_agexfores/69
- "SP660 Lichens and Vines on Trees," The University of Tennessee Agricultural Extension Service, SP660-15M-9/05 R12-4910-051-005-06 06-0070, http://trace.tennessee.edu/utk_agexfores/81
- "SP682 Watering Trees," The University of Tennessee Agricultural Extension Service, SP682-13.5M-10/06 R12-4910-065-008-07 07-0072, http://trace.tennessee.edu/utk_agexfores/82
- "SP683 Tree Wounds - Response of Trees and What You Can Do," The University of Tennessee Agricultural Extension Service, SP683-13.5M-10/06 R12-4910-065-009-07 07-0073, http://trace.tennessee.edu/utk_agexfores/83
- "SP686 Dieback and Decline of Trees," The University of Tennessee Agricultural Extension Service, SP686-13.5M-10/06 R12-4910-065-012-07 07-0076, http://trace.tennessee.edu/utk_agexfores/86
- "SP687 Tree Owner's Rights and Responsibilities," The University of Tennessee Agricultural Extension Service, SP686-13.5M-10/06 R12-4910-065-013-07 07-0077, http://trace.tennessee.edu/utk_agexfores/87

- Right-of-Way Vegetation Maintenance-TVA , <http://www.tva.gov/power/rightofway/faq.htm>
- UTIA Soil, Plant and Pest Center: This webpage provides instructions on how to collect, prepare and send plant disease and insect specimen to the Center for diagnosis. <https://ag.tennessee.edu/spp/Pages/plantpestdiagnosis.aspx>

Tennessee Government and Other Organization Resources

- Arbor Day Foundation: This foundation is the largest nonprofit membership organization dedicated to planting trees, with over one million members, supporters, and valued partners. <http://www.arborday.org>
- Tennessee Department of Agriculture Division of Forestry, <http://tn.gov/agriculture/section/forests>
- Tennessee Department of Environment and Conservation (TDEC): TDEC's department programs and initiatives protect human health and the environment and support economic development and quality of life through education, outreach and effective enforcement of state and federal environmental laws. <http://www.tn.gov/environment>
- Tennessee Smart Yards: Tennessee Smart Yards is a University of Tennessee-led program that guides and assists Tennessee residents and neighborhood associations on practices they can apply in their yards and common spaces to create healthier living spaces and communities. <https://ag.tennessee.edu/tnyards>
- Tennessee Urban Forestry Council (TUFC): TUFC promotes healthy and sustainable urban and community forests that contribute to clean air and water, economic stability, and beautiful green places. <http://www.tufc.com>
- Tennessee Wildlife Resources Foundation (TWRF): TWRF is a nonprofit organization that supports the Tennessee Wildlife Resources Agency (TWRA) and promotes habitat conservation, responsible land stewardship, and the preservation of Tennessee's hunting and fishing heritage. <http://www.twrf.net>
- Urban Forestry South (UFS): UFS focuses on technology and information that supports urban forest management, tree health, tree biology, and the measurement of ecosystem benefits derived from trees in urban settings. <http://www.urbanforestrysouth.org>
- UT Forest Resources AgResearch and Education Center: The University of Tennessee Forest Resources AgResearch and Education Center is a 11,500-acre field research laboratory headquartered in Oak Ridge, TN. The Center develops new technologies applicable to modern forestry and wildlife resources management and environmental stewardship. <http://forestry.tennessee.edu/>
- Wild Ones Tennessee Valley Chapter: The Tennessee Valley Chapter of Wild Ones is an organization for those interested in landscaping with native plants. <http://tennesseevalley.wildones.org/>

References

- Assessing your property the first step in developing a streambank or shoreline landscape/Tennessee Valley Authority. 2008. Riparian restoration fact sheets series ; no. 3. Tennessee Valley Authority, Knoxville, TN. <http://purl.access.gpo.gov/GPO/LPS106849> (accessed January 13, 2015).
- Benefits of riparian zones that use native plants/Tennessee Valley Authority. 2008. Riparian restoration fact sheets series ; no. 2. Tennessee Valley Authority, Knoxville, TN. <http://purl.access.gpo.gov/GPO/LPS106845> (accessed January 13, 2015).
- Bentrup, G. 2008. Conservation Buffers—Design guidelines for buffers, corridors, and greenways. Gen. Tech. Rep. SRS-109. Asheville, NC: U.S. Department of Agriculture, Forest Service, Southern Research Station. 110 p. <http://www.srs.fs.usda.gov/pubs/33522/> (accessed January 13, 2015).
- Burns, Russell M., and Barbara H. Honkala, tech. coords. 1990. Silvics of North America: 1. Conifers; 2. Hardwoods. Agriculture Handbook 654.
- U.S. Department of Agriculture, Forest Service, Washington, DC. vol.2, 877 p.http://www.na.fs.fed.us/spfo/pubs/silvics_manual/table_of_contents.htm (accessed August 10, 2015).
- Darke, Rick and Tallamy, Doug. 2014. The Living Landscape: Designing for Beauty and Biodiversity in the Home Garden. 1st ed. Timber Press, Inc. 392 p.
- Designing your landscape the second step in developing a streambank or shoreline landscape / Tennessee Valley Authority. 2008. Riparian restoration fact sheets series ; no. 4. Tennessee Valley Authority, Knoxville, TN. <http://purl.access.gpo.gov/GPO/LPS106850> (accessed January 13, 2015).
- Hawes, Ellen and Markelle Smith. 2005. Riparian Buffer Zones: Functions and Recommended Widths. Yale School of Forestry and Environmental Studies. For the Eightmile River Wild and Scenic Study Committee.
- Hunter, Margie. 2002. Gardening with the Native Plants of Tennessee: The Spirit of Place. Knoxville: University of Tennessee Press.
- Landscaping alternatives one site, three solutions / Tennessee Valley Authority. 2008. Riparian restoration fact sheets series ; no. 6. Tennessee Valley Authority, Knoxville, TN. <http://purl.access.gpo.gov/GPO/LPS106851> (accessed January 13, 2015).
- Landscaping with plants, Tennessee: Promoting Biodiversity Endorsing a Land Ethic that Celebrates Our Natural Heritage. 2010. <http://s3.amazonaws.com/tneppc2/uploads/583/original/natives2010-web.pdf> (accessed June 15, 2015).

Native Plant Information Network, NPIN (2013). Published on the Internet <http://www.wildflower.org/plants/> (accessed August 20, 2015). Lady Bird Johnson Wildflower Center at The University of Texas, Austin, TX.

Native plants of the Tennessee Valley/ Tennessee Valley Authority. 2008. Riparian restoration fact sheets series; no. 5. Tennessee Valley Authority, Knoxville, TN. <http://purl.access.gpo.gov/GPO/LPS106847> (accessed January 13, 2015).

Planting and maintaining your native landscape to ensure survival of your plants/Tennessee Valley Authority. 2008. Riparian restoration fact sheets series; no. 9. Tennessee Valley Authority, Knoxville, TN. <http://purl.access.gpo.gov/GPO/LPS106854> (accessed January 13, 2015).

PlantNative. 2004. Native Plant List—Kentucky and Tennessee. <http://www.plantnative.org/rpl-kytn.htm> (accessed June 15, 2015). Portland, OR 97228 USA.

Preparing the site to provide suitable conditions for planting/Tennessee Valley Authority. 2008. Riparian restoration fact sheets series; no. 7. Tennessee Valley Authority, Knoxville, TN. <http://purl.access.gpo.gov/GPO/LPS106853> (accessed January 13, 2015).

Understanding erosion/Tennessee Valley Authority. 2008. Riparian restoration fact sheets series; no. 7. Tennessee Valley Authority, Knoxville, TN. <http://purl.access.gpo.gov/GPO/LPS106846> (accessed January 13, 2015).

Using native vegetation to protect streambanks and shorelines in the Tennessee Valley/ Tennessee Valley Authority. 2008. Riparian restoration fact sheets series ; no. 1. Tennessee Valley Authority, Knoxville, TN. <http://purl.access.gpo.gov/GPO/LPS106848> (accessed January 13, 2015).

Tallamy, Douglas W. 2007. Bringing Nature Home: How Native Plants Sustain Wildlife in Our Gardens. Timber Press, Inc. 288 p.

Tu, M., Hurd, C., & J.M. Randall, 2001. Weed Control Methods Handbook, The Nature Conservancy, <http://tncinvasives.ucdavis.edu>, Version: April 2001. <http://www.invasive.org/gist/handbook.html> (accessed June 15, 2015).

USDA, NRCS. 2015. The PLANTS Database (<http://plants.usda.gov>, accessed August 10, 2015). National Plant Data Team, Greensboro, NC 27401-4901 USA.

University of Tennessee. 2015. Tennessee Smart Yards Native Plant Database, <https://tynnativeplants.wordpress.com> (accessed June 15, 2015). Knoxville, TN 37996 USA.

Wasowski, Sally, 2010. Gardening with Native Plants of the South. Taylor Trade Publishing. 216 p.

Photo and Illustration Credits

Photo Credits

- Roy Arthur, TNWRRC - Figure E-1
- Jeff Barrie, TEC - Figure 1
- Ruth Anne Hanahan, TNWRRC - plant photo in call out in box “Native Plant Sources”, Figure 5 images, Figure 21, Figure 22, Figures E-1, E-2, E-3, E-4, E-5, E-6.
- Knox County Stormwater - Figure 32
- Joseph Konvicka, Knox County AmeriCorps - Figure 33
- Reggie Reeves, TDF - Figures 29, 30, 34, 35, 36; Buffer images in Appendix A (one image at top of page A1; 2 images at bottom of page A-4)
- TNWRRC and TVA, Figure 7 and bottom of page A-3
- © 2008 HaarFager at [en.wikipedia GFDL \(http://www.gnu.org/copyleft/fdl.html\)](http://www.gnu.org/copyleft/fdl.html). - Figure 19
- **Weed Control Methods Handbook**, Tu et al., 2001; <http://www.invasive.org/gist/handbook.html> - Figure 20

Illustration Credits

The following illustrations are original works by Katie Walberg, TNWRRC: Cover illustration; Figures 6, 9a, 9b, 10, 11, 12, 13, 14, 15a, 15b, 15c, 16a, 16b, 16c, 17a, 17b, 17c, 18a, 18b, 23, 24, 25, 26, 27, 28, and 31; top of page A-3; all illustrations in Appendix C; illustrations on pages G-2 and G3; flyer and signage illustration on pages F-9, F-10 and G-5

The following illustrations are adaptations by Katie Walberg, TNWRRC:

- Figure 2 and Page A-1 adapted from Hawes and Smith, 2005;
- Figure 4 and Page A-2, adapted from Layers in Forest Strata, <https://quizlet.com/16239412/animal-ecologyset-iv-flash-cards/>, Accessed January 9, 2015.
- Figure 8 adapted from illustration by Dede Christopher, TVA, <http://www.tva.gov/river/landandshore/stabilization/pdf/benefits.pdf>;
- Table 4 and page G-1 adapted from www.tnonecall.com to fit style of handbook.
- Figure E-7 Le wand adapted from Tu et al., 2001, <http://www.invasive.org/gist/tools/wand.html>

The following illustrations are drawings by Katie Walberg, TNWRRC over photographic images: Figure 3 drawing over ©2014 Google Earth image); Figure 5.

This page intentionally left blank

Appendices

These appendices reflect the content of this Handbook and are intended to be used as tools to support its implementation. This includes: 1) preparing volunteers to help with riparian plantings, 2) developing riparian buffer plans, and 3) conducting community planting events.

- A. The Tennessee Urban Riparian Buffer
- B. Tennessee Riparian Buffer Site Assessment
- C. Creating a Tennessee Urban Riparian Buffer
- D. Tennessee Native Riparian Plants List
- E. The Threat of Invasive Plants to Tennessee Urban Riparian Buffers
- F. Organizing and Conducting a Riparian Buffer Community Planting
- G. Properly Installing Plants: How to Plant Trees and Shrubs

This page intentionally left blank

A. The Tennessee Urban Riparian Buffer

A riparian buffer is a transitional area between land and water that contains a mix of trees, shrubs, grasses and wildflowers.

Healthy riparian buffers are the first natural line of defense in protecting our waterways. The state of Tennessee has over 60,000 miles of streams and rivers that are increasingly being threatened by a rapidly developing landscape. In neighborhoods, commercial areas and even parks buffers have often been reduced or eliminated. This handout introduces buffers—their vital functions, how they change over time, and an approach to re-establishing them within our communities.

The Functions of Buffers

Healthy riparian buffers provide a range of environmental, economic, and social functions that are of significant benefit to our communities.

- Stabilizes banks: Roots bind soils, reducing erosion that can result in property loss and sediment input that can harm our waterways
- Improves water quality: Plants slows down and trap stormwater pollutants like sediment, pathogens, and nutrients, creating healthier waterways for aquatic life and recreation.
- Manages flood control: Green space provides storage for water during heavy rains, reducing local flood damage.
- Creates aquatic and terrestrial habitat: Overhanging branches create shade that cools the water and contributes organic materials that are used as in-stream food sources. On land, plants provide food and shelter for birds and other wildlife. Both on land and in the waterway, biodiversity is increased.

The Wider the Buffer the Greater the Benefits

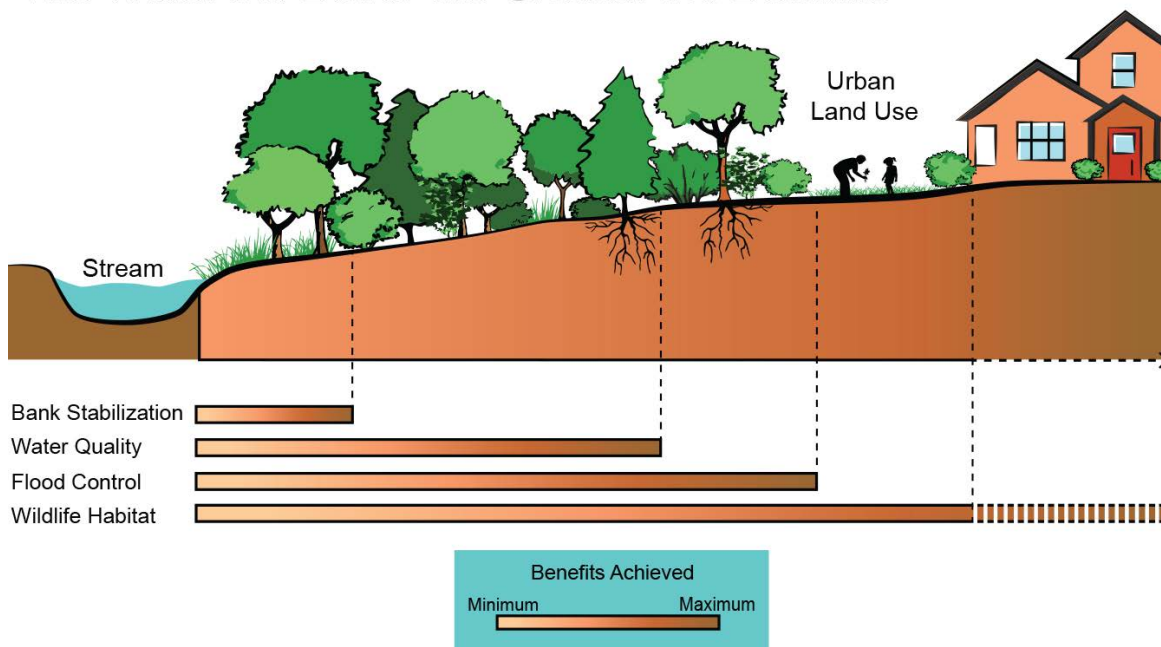

The Ecology of Buffers: Succession

A riparian buffer changes in appearance and functions over time through a process referred to as ecological succession. From planting to maturity, these changes can be placed into three stages:

1. Early: Soon after installing tree and shrub seedlings in an open sunny streamside area, many opportunistic plants will seek to establish themselves, competing for space, nutrients and sun. This will include herbaceous unwanted plants (a.k.a. weeds) that result in an “unkept” or “wild and wooly” appearance.



2. Middle: As the installed shrubs and trees gain height, they will begin to provide shade. The shade will help to suppress weed growth, providing the shrubs and trees with a competitive edge.

3. Late: After eight to ten years, the buffer will begin to take on more of the characteristics of a mature and healthy woodland, with distinctive vegetative layers.

- The upper layer or canopy serves the critical function of providing shade for the adjacent waterbody, cooling water temperatures needed for healthy aquatic life.
- The canopy and subcanopy (lower canopy) layers provide an environment for the understory tree and shrub species that require less light. The diversity of plants with varying heights create habitat for native bird and other wildlife.

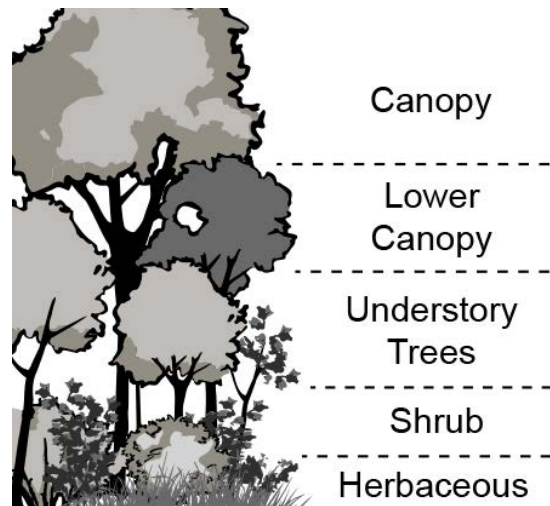

Over time, the riparian soils will become more enriched in organic matter from decaying leaves and other detritus. The fertile ground will more readily germinate new growth and contain more microbes that can help breakdown stormwater contaminants. The high levels of organics will also serve as a sponge to help absorb stormwater overland flow.

Challenges to Creating Riparian Buffers in Urban Environments

Urban areas present a range of challenges for establishing buffers, and the model buffer may not be feasible. In older developed areas, waterside development may have occurred before there were any building restrictions, allowing minimal space for re-establishing a buffer. Past land management practices such as the installation and mowing of turf grass along the water's edge may have created unstable and eroding stream banks. High flashy flows may have damaged streamside areas that were sparsely planted.

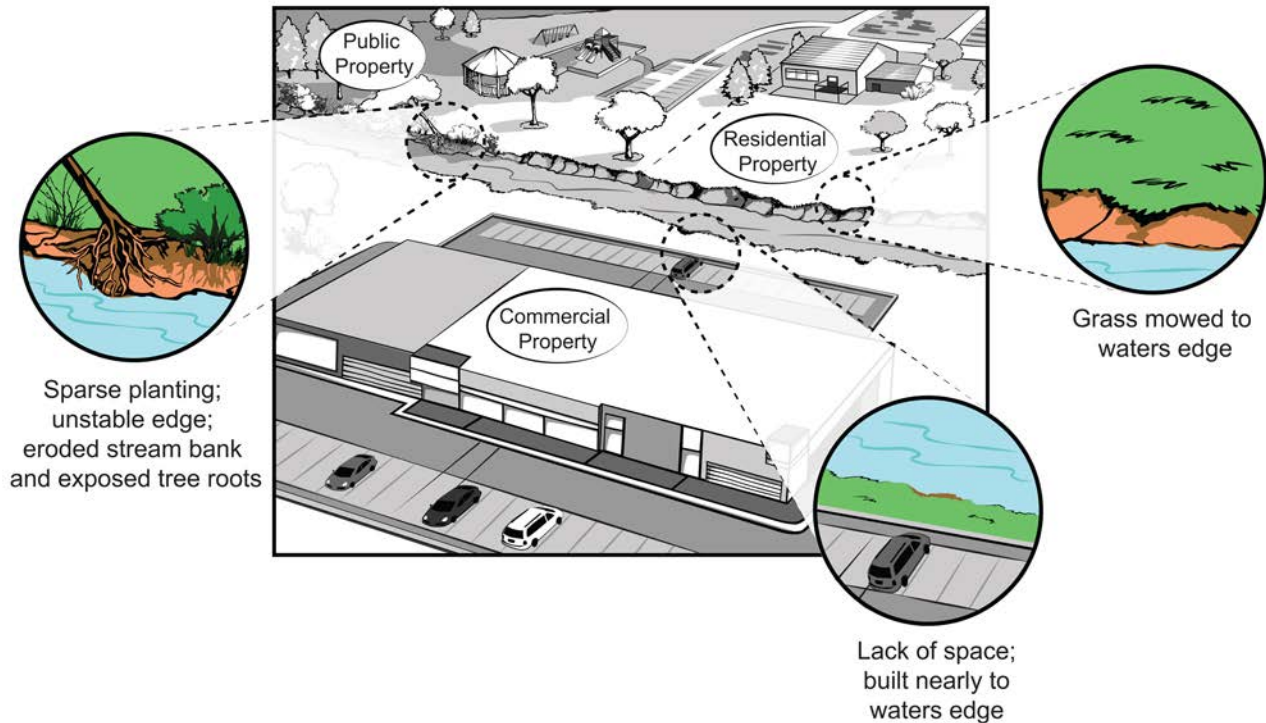

Although they may not be ideal, there are many opportunities in urban settings to re-establish buffers. Consider three important tenets in these situations:

- 1. Some buffer is better than no buffer.**
- 2. The wider the buffer, the more benefits the buffer will provide.**
- 3. Not all buffers are created equal.**

The types of plants make a difference in how effectively buffers can function. For example, vegetation comprised solely of grasses will not adequately protect the streambank against erosion, while one comprised of shrubs will not provide sufficient shading for the adjacent waterbody.



Approaches to Installing Buffers

There are two ways to consider establishing a buffer. The **passive** approach is more hands-off. It is where the riparian area is allowed to naturally colonize and mature into a forested area through ecological succession. This is done generally by creating a “no mow zone” area through signage or fencing. Benefits include:

- No planting is done.
- Requires less time and monetary resources.

A buffer can also be more **actively established** by intentionally planning and implementing its installation. Although it takes more resources, its benefits include:

- Greater control over the composition of the buffer and its appearance.
- More assurance it will function to its greatest capacity.

A community group approach to planting buffers can save time and resources and also offer a way to involve the public in the protection of our state’s waterways. Information on how to plan and conduct a riparian buffer community event can be found in the **The Tennessee Urban Riparian Buffer Handbook**.

Community Group Establishing an Urban Riparian Buffer



The Tennessee Urban Riparian Buffer Handbook Series

This handout is one of a series of supporting appendices to the **Tennessee Urban Riparian Buffer Handbook**. To download go to: <http://tn.gov/agriculture/topic/ag-forests-urban>

- A. The Tennessee Urban Riparian Buffer
- B. Tennessee Riparian Buffer Site Assessment
- C. Creating a Tennessee Urban Riparian Buffer
- D. Tennessee Native Riparian Plants List
- E. The Threat of Invasive Plants to Tennessee Urban Riparian Buffers
- F. Organizing and Conducting a Riparian Buffer Community Planting
- G. Properly Installing Plants: How to Plant Trees and Shrubs

B. Tennessee Riparian Buffer Site Assessment

This form is intended to document a potential riparian planting site and to serve as a prioritization tool for scoring and comparing it against other potential planting sites.

I. Project Site Landowner/Address

Landowner Name: _____

Landowner Contact (Phone/Email): _____

Project Street Address: _____

City: _____ Zip: _____

Land Ownership (circle one): Federal State City NGO Private

Stream Name (or nearest downstream): _____

II. Existing Riparian Buffer Characteristics

Does the landowner own land on both sides of the stream? Yes No

Stream frontage on left side facing downstream

- Length in ft: _____
- Current buffer condition (circle one):
Bare Soil Open/Mowed Shrubs Shrubs/Trees Trees
- Existing buffer width (mix of trees, shrubs, grasses) in ft (measure from top of stream bank to buffer edge): _____

Stream frontage on right side facing downstream

- Length in ft: _____
- Current buffer condition (circle one):
Bare Soil Open/Mowed Shrubs Shrubs/Trees Trees
- Existing buffer width (mix of trees, shrubs, grasses) in ft (measure from top of stream bank to buffer edge): _____

Attach a map: *Shade in the targeted planting area on a map (e.g., Google map, local tax map).*

III. Site Assessment

A. Is the landowner supportive of the riparian planting and willing to ensure that the riparian buffer will be protected?

If NO, eliminate this site as a candidate. **If YES**, answer the questions in Section B.

- B. Answer the following questions to score the candidate buffer planting site and then use that score to rank it against other sites being considered for planting. Assign one point for a “yes” answer. The site with the lowest total score is given the higher priority in planting.

CANDIDATE SITE ASSESSMENT QUESTIONS	Yes (1)/ No (0)
<p>1. Does the buffer contain a mix of trees, shrubs, and herbaceous plants (grasses, wildflowers)?</p> <p>An ideal buffer contains a mix of native vegetation that maximizes a buffer’s functions and benefits (see Appendix A). For example, if the area is mostly grasses, it would receive a score of zero.</p>	
<p>2. Is the width of the existing buffer (mix of trees, shrubs, grasses) on each side of the bank at least twice the width of the waterbody?</p> <p>This question assesses whether there is currently an adequate buffer width and is based on a Natural Resources Conservation Service (NRCS) guideline.</p>	
<p>3. Does the site offer shading to the stream or contain seedlings or saplings that will mature into shade-bearing trees?</p> <p>A critical function of an urban buffer is to provide at least partial shading to the adjacent waterway to allow for cooling of its waters. Many aquatic insects and fish cannot survive in warm waters and in urban areas where the source of runoff is often from blacktop, shading by trees is of utmost importance.</p>	
<p>4. Are the banks free of active excess erosion? A good indication is that you can walk along the edge without concern of a bank collapsing.</p> <p>Actively eroding streambanks are an indication that there is insufficient root protection being provided by the streamside plants. In urban areas where the water flows can be “flashy” (i.e., rise and fall quickly) and carry a great deal of energy, it is particularly important that the stream banks be well protected by an extensive and deep root system.</p>	
TOTAL POINTS	

NOTES:

The Tennessee Urban Riparian Buffer Handbook Series

This handout is one of a series of supporting appendices to the **Tennessee Urban Riparian Buffer Handbook**. To download go to: <http://tn.gov/agriculture/topic/ag-forests-urban>

- A. The Tennessee Urban Riparian Buffer
- B. Tennessee Riparian Buffer Site Assessment
- C. Creating a Tennessee Urban Riparian Buffer
- D. Tennessee Native Riparian Plants List
- E. The Threat of Invasive Plants to Tennessee Urban Riparian Buffers
- F. Organizing and Conducting a Riparian Buffer Community Planting
- G. Properly Installing Plants: How to Plant Trees and Shrubs

C. Creating a Tennessee Urban Riparian Buffer Plan

Introduction

The installation of a riparian buffer can most effectively and efficiently be done by initially devising a simple riparian buffer plan. This handout is intended to assist with its creation providing a set of steps to follow and factors to consider. It includes conducting a site assessment and developing a planting schematic that can be used to determine plant types and quantities to purchase. Its planting approach primarily incorporates the installation of bare root seedlings using one planting density, creating a plan that is low cost, easily installed, and maximizes stormwater and water quality benefits.

STEP 1: Consider how the buffer will be used

Waterside areas offer a range of opportunities for recreation and it is important to incorporate planned uses into the buffer plan.

Physical Access to the Waterway

Physical access points to a waterway may be desired for fishing, canoe launching, or picnicking. When planning, consider the following questions:

1. What is the intended use(s) of this access?
2. What ways could this access be used that are undesirable?
3. Do the benefits of having this access outweigh the potential drawbacks?

Once the uses are identified, the access point can be designed to meet these needs. Three design factors include access width, ground cover, and bank stability.

1. Access Width

Identify the narrowest possible width for the access point's intended use(s). For example, a three foot wide path may be sufficient for a homeowner who only plans to use the access for fishing. It may also limit unwanted uses by being narrow enough to go unnoticed or be used for unintended purposes.

Waterside Access Point Width Examples (feet)	
Homeowner fishing	3 ft
Picnic area with table	6-8 ft
Kayak/canoe launch	6-12 ft

2. Ground Cover

It is important to ensure that any exposed soils are minimal. Paths can be planted and maintained in grasses, or they may be covered in wood chips or gravel. Both options have their benefits and limitations. Grasses may be more appropriate for wider pathways that offer sufficient sun exposure, and wood chips may be washed away during periods of flooding. Consideration may be given to installing a mix of low-growing native grasses.

Initially, narrow paths may be planted in grasses but over time they may be shaded out by adjacent shrubs and trees and require another option such as wood chips or gravel. Many tree service companies will provide wood chips for free and may also deliver them when working in an area, while some municipalities may offer free or low cost mulch through their solid waste department.

3. Bank Stability

The bank fronting a waterway's access point should be planted minimally in low growing shrubs to offer protection from bank erosion. If a canoe or kayak launch is desired within the buffer, additional factors need to be considered including safety. The National Park Service's Rivers and Trails program provides a comprehensive design guide for a range of canoe and kayak launches entitled "Logical, Lasting Launches"

(<http://www.nps.gov/ncrc/programs/rtca/helpfultools/launchguide.pdf>).

Visual Access to the Waterway

"Windows" to a waterway may be created by strategically placing swaths of low-growing shrubs among the mix of taller growing trees and shrubs. In some urbanized situations, such as on school campuses, this may be necessary to create visual lines of site from one area of the campus to another. If this is being considered in the riparian plan, consider the following questions to help determine window width and placement.

1. Where will the viewer(s) most likely be located?
2. What is the narrowest width that can be used to meet site needs?
3. Is the access worth the long-term maintenance requirements?

The narrowest window option is always preferable since the streamside placement of only low-growing shrubs eliminates the buffer benefit of shading the adjacent waterway. There is also the consideration of long-term maintenance of these windows. With them being flanked by taller trees and shrubs, it is inevitable that taller shrubs and trees will migrate into the area requiring periodic removal.

Utility Line Access

Utility companies have easements to run lines through properties and most have planting restrictions as a part of the easement agreements. For above ground power lines, there are typically limitations on installing plants of a certain height. If the buffer is potentially in an easement, contact the utility company to determine planting stipulations and whether the utility requires the submission of a planting plan. The risk of not contacting the company is that your installed plants may be mowed or sprayed with herbicide.

By state law, you are required to contact Tennessee811 to have underground utilities marked before any digging at the buffer site can occur.

STEP 2: Conduct a site inventory

Key information about the targeted buffer site needs to be collected in order to create a planting plan. The most effective way to collect this information is to visit the site to make and record observations. The **Targeted Buffer Site: Inventory** worksheet on page C-7 can be used to create a site inventory sketch. Consider incorporating the following factors:

- Native plants to be retained
- Invasive plants to be removed
- Saturated “soggy” ground (may be indicated by water-loving plants like sedges or rushes)
- Above-ground utilities and signs of underground utilities
- Potential safety hazards (e.g., holes in ground) to consider on the day of planting
- Adjacent buildings, taking note of vantage points to the buffer (e.g., from patio)

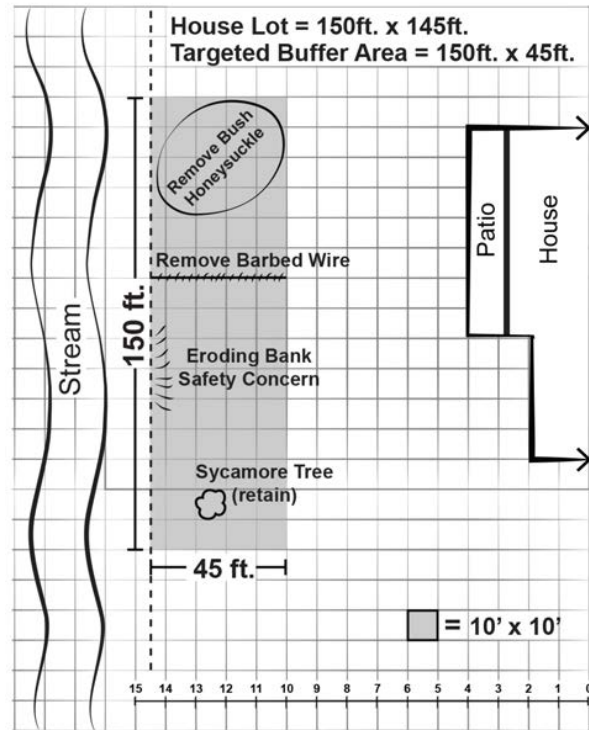

STEP 3: Create a plant layout

The planting layout defines the areas targeted for planting. It should include the site factors that will affect the size of the planting areas. The **Targeted Buffer Site: Planting Layout** worksheet on page C-8 can be used to create this schematic that could include:

- Walking paths(s)
- “Windows” for visual access to the waterway
- Kayak access
- Streamside picnic area
- Above and underground utilities

The scale of the grid can be adjusted according to the size of the site.

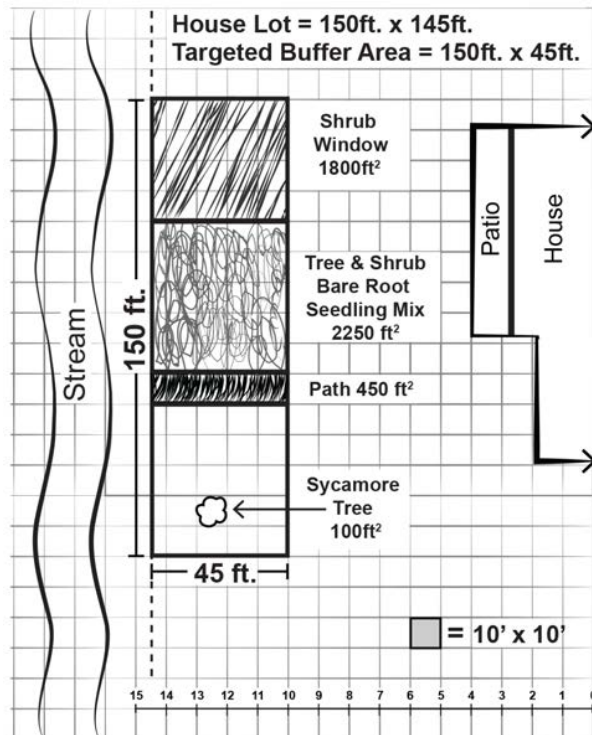

STEP 4: Determine plant stock and quantities

It is recommended for low-cost buffer plantings to primarily use **bare root seedlings**. **Container** and **“balled and burlapped” (B&B)** plants are much more expensive but may be strategically used for aesthetics. For example, they can be used as a buffer border, creating a neater edge and screening the remaining buffer as it goes through its early successional stages.

Plant Density Guidelines: The type of plant stock will determine how the plants are spaced or their planting density.

Bare root seedlings are to be placed about **six feet apart from one another**. Another way to visualize this spacing is that the seedling is located in the center of a 36 foot square. The reason for this “one size fits all” planting density is to ensure a high density planting that maximizes stormwater and water quality benefits and allows for some expected mortality of seedlings.

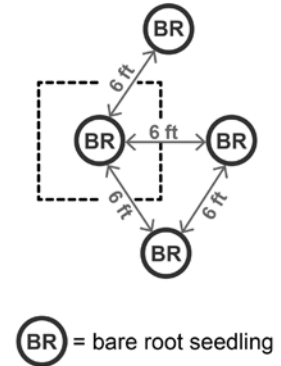

Container or B&B plant stock can be placed about 10 feet apart from one another. By alternating trees and shrubs more visual interest and diversity can be created.

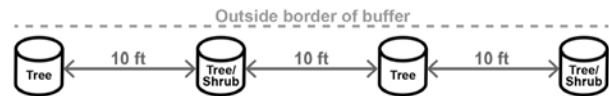

Knowing the size of a planting area and the planting density, plant quantities can easily be determined. Following is an example of planting quantities for a half-acre residential lot where the landowner wants a “window” to view the stream and a pathway to access it for fishing.

Example of Plant Quantity Determination

Half-Acre Residential Lot: Buffer with “Window”, Path, and Visual Screen

Plan: A “window” with shrubs of low to moderate height will be located in front of the home’s front porch and a mulch walking path to the stream will be installed. A row of container/B&B trees/shrubs will be planted along the inside edge of the buffer to serve as a visual screen.

Total Buffer Area = 45 ft buffer width X 150 ft buffer length = 6750 ft²

Path = 45 ft X 10 ft = 450 ft²

“Shrub Window” Planting Area = 45 ft x 30 ft = 1350 ft²

Tree/Shrub Planting Area = 6750 ft²- 450 ft²- 1350 ft²= 4,950 ft²

of Bare Root Seedlings

- Tree/Shrub Mix = 4950 ft² / 36 ft² = 138
- Shrub Window = 1350 ft² / 36 ft² = 38

Container/B&B Plants

- 150 ft buffer length - 30 ft shrub window - 10 ft path = 110 linear feet
- 110 linear ft / 10 ft spacing = 11

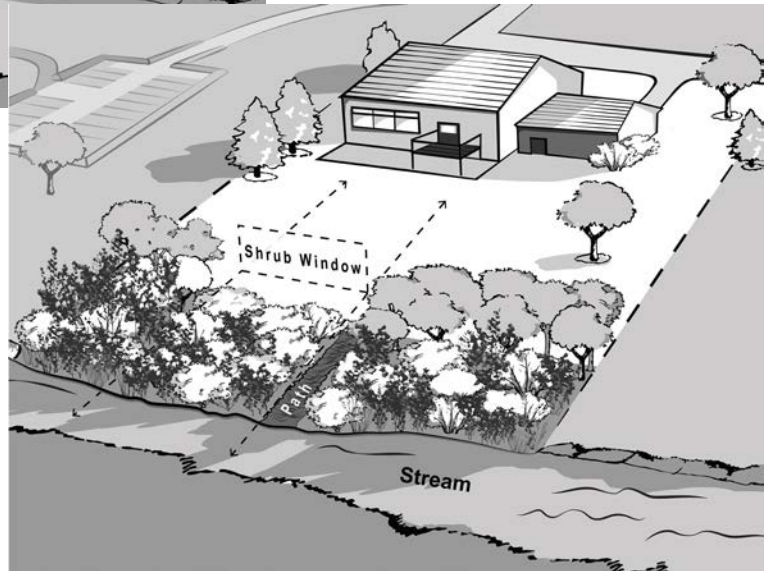
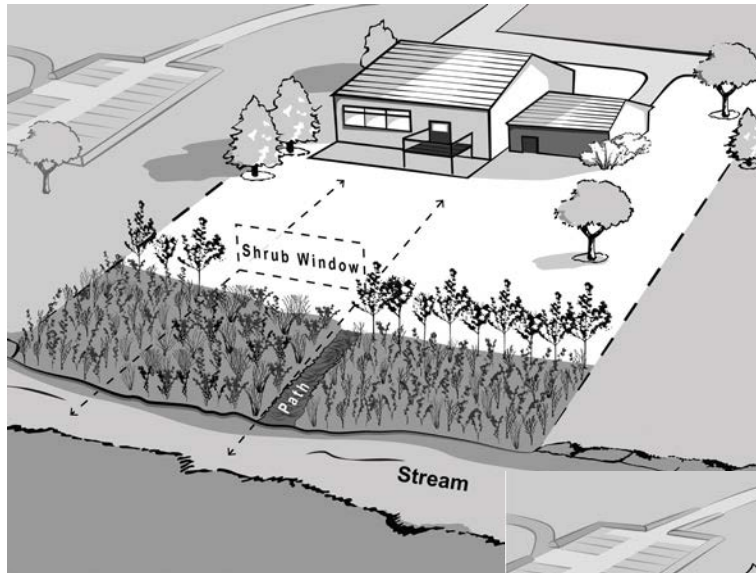

Plant Selection Considerations: A number of factors can be considered when selecting plant species for the buffer site. These include whether they are native to a particular region of Tennessee, their plant form, their preferred growing conditions, their wildlife value and appearance (see “D. Tennessee Native Riparian Plant List”).

Mix of Plant Species: In determining the number and mix of plant species, no one species should dominate and there should be enough species that if one or two species do not make it, a healthy buffer stand will remain. Consider the following guidelines to help achieve these objectives:

- No one species should comprise more than 20% of the mix of species.
- Include a mix of canopy, subcanopy and shrub species, with about 60% or more of the total plant count consisting of canopy trees.

Another factor that needs to be considered when purchasing bare root seedlings is that most nurseries provide them in multiples of 25 or 100. If extra plants are purchased as a result, consider overplanting the buffer site or using them as give-a-ways.

Example of Plant Type and Mix
Half-Acre Residential Lot: Buffer with “Window”, Path and Visual Screen

About 180 bare root seedlings are required in this scenario, with about 40 being relatively low growing shrubs for the “window.” Following is a mix of plants for this site. The numbers take into account that the seedlings will be purchased in bundles of 25. In addition, a mix of 11 available container and/or B&B trees and shrubs of the same species (e.g. red maple, tulip poplar, wild hydrangea) could be purchased for the buffer’s edge that would create a visual screen.

Canopy	#	Subcanopy	#	Shrubs	#	Total
Willow oak	25	Red mulberry	25	Wild hydrangea	25	75
Shumard oak	25			Hearts-a-bustin	25	50
Tulip poplar	25					25
Red maple	25					25
Sweetgum	25					25
Total	125		25		50	200

The Tennessee Urban Riparian Buffer Handbook Series

This handout is one of a series of supporting appendices to the **Tennessee Urban Riparian Buffer Handbook**. To download go to: <http://tn.gov/agriculture/topic/ag-forests-urban>

- A. The Tennessee Urban Riparian Buffer
- B. Tennessee Riparian Buffer Site Assessment
- C. Creating a Tennessee Urban Riparian Buffer
- D. Tennessee Native Riparian Plants List
- E. The Threat of Invasive Plants to Tennessee Urban Riparian Buffers
- F. Organizing and Conducting a Riparian Buffer Community Planting
- G. Properly Installing Plants: How to Plant Trees and Shrubs

Targeted Buffer Site: Inventory

Location: _____ Date: _____

Lot Dimensions: _____ Buffer Area Dimensions: _____

A large grid of graph paper, consisting of 20 columns and 30 rows of small squares, intended for site inventory.

Targeted Buffer Site: Planting Layout

Location: _____ Date: _____

Lot Dimensions: _____ Buffer Area Dimensions: _____

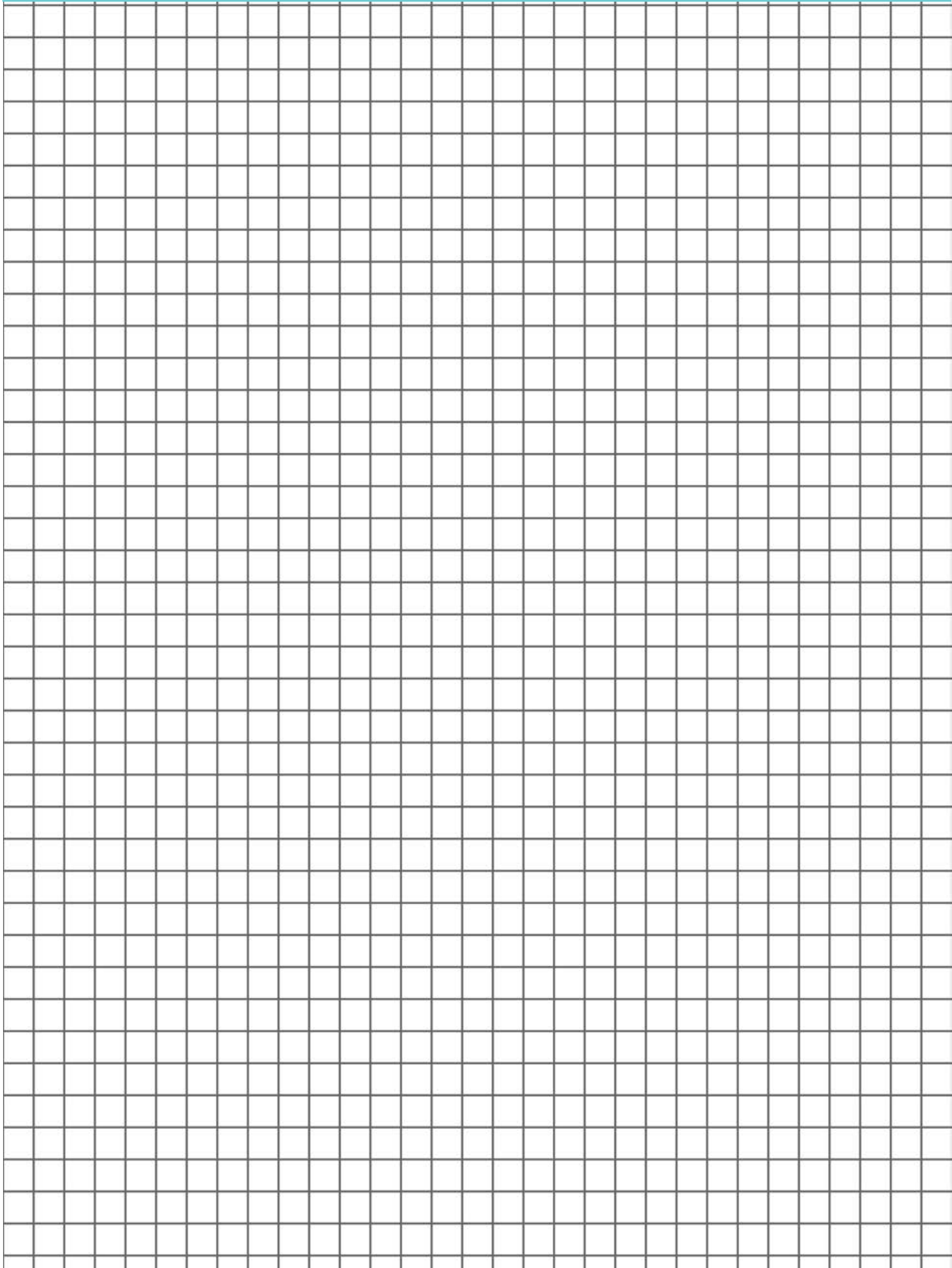

D. Tennessee Native Riparian Plant List

The Tennessee Native Riparian Plant List list is a collaborative work. We started with the framework of the general plant list in the Tennessee Permanent Stormwater Manual and sent it out for review to plant experts within state and federal government, universities, nonprofit organizations and private nurseries from across the state of Tennessee. Reviewers responded by ranking native plants for urban riparian buffers within their state region, West, Middle or East Tennessee.

The following pages list the native plants by region: West, Middle and East Tennessee. The regional divisions that were used for the plant list are shown on this map of Tennessee at <http://tn.gov/agriculture/topic/ag-forests-state-forests>. Within each region the native plants are categorized by vegetative layers:

- Canopy - largest trees 50-100 feet tall or more
- Understory - small trees or large shrubs 15-50 feet tall
- Shrub - wood stems from less than one foot to 15 feet tall
- Grasses and Sedges - vary in height

Within the list for each region is a direct weblink to the USDA PLANTS database for each species, <http://plants.usda.gov>.

The descriptive table lists all plants together in their categories in alphabetical order by scientific name depicting height, light requirements, soil moisture, soil pH, wildlife benefits and aesthetics (e.g. flowers, fall color).

West Tennessee Native Riparian Plant List

Common Name	Scientific Name	USDA PLANTS Database
CANOPY		
Red maple	<i>Acer rubrum</i>	http://plants.usda.gov/core/profile?symbol=ACRU
River birch	<i>Betula nigra</i>	http://plants.usda.gov/core/profile?symbol=BENI
Pecan	<i>Carya illinoensis</i>	http://plants.usda.gov/core/profile?symbol=CAIL2
Common persimmon	<i>Diospyros virginiana</i>	http://plants.usda.gov/core/profile?symbol=DIVI5
Sweetgum	<i>Liquidambar styraciflua</i>	http://plants.usda.gov/core/profile?symbol=LIST2
Tulip poplar	<i>Liriodendron tulipifera</i>	http://plants.usda.gov/core/profile?symbol=LITU
Blackgum tupelo	<i>Nyssa sylvatica</i>	http://plants.usda.gov/core/profile?symbol=NYSY
Sycamore	<i>Platanus occidentalis</i>	http://plants.usda.gov/core/profile?symbol=PLOC
Eastern cottonwood	<i>Populus deltoides</i>	http://plants.usda.gov/core/profile?symbol=PODE3
Swamp white oak	<i>Quercus bicolor</i>	http://plants.usda.gov/core/profile?symbol=QUBI
Overcup oak	<i>Quercus lyrata</i>	http://plants.usda.gov/core/profile?symbol=QULY
Burr oak	<i>Quercus macrocarpa</i>	http://plants.usda.gov/core/profile?symbol=QUMA2
Swamp chestnut oak	<i>Quercus michauxii</i>	http://plants.usda.gov/core/profile?symbol=QUMI
Chinkapin oak	<i>Quercus muehlenbergii</i>	http://plants.usda.gov/core/profile?symbol=QUMU
Cherrybark oak	<i>Quercus pagoda</i>	http://plants.usda.gov/core/profile?symbol=QUPA5
Willow oak	<i>Quercus phellos</i>	http://plants.usda.gov/core/profile?symbol=QUPH
Shumard oak	<i>Quercus shumardii</i>	http://plants.usda.gov/core/profile?symbol=QUSH
Nuttall oak	<i>Quercus texana</i> (formerly <i>Q. nuttallii</i>)	http://plants.usda.gov/core/profile?symbol=QUTE
Black willow	<i>Salix nigra</i>	http://plants.usda.gov/core/profile?symbol=SANI
Bald cypress	<i>Taxodium distichum</i>	http://plants.usda.gov/core/profile?symbol=TADI2

West Tennessee Native Riparian Plant List

Common Name	Scientific Name	USDA PLANTS Database
UNDERSTORY		
Red buckeye	<i>Aesculus pavia</i>	http://plants.usda.gov/core/profile?symbol=AEPA
Serviceberry	<i>Amelanchier arborea</i>	http://plants.usda.gov/core/profile?symbol=AMAR3
Serviceberry	<i>Amelanchier laevis</i>	http://plants.usda.gov/core/profile?symbol=AMLA
Pawpaw	<i>Asimina triloba</i>	http://plants.usda.gov/core/profile?symbol=ASTR
American hornbeam	<i>Carpinus caroliniana</i>	http://plants.usda.gov/core/profile?symbol=CACA18
Eastern redbud	<i>Cercis canadensis</i>	http://plants.usda.gov/core/profile?symbol=CECA4
Roughleaf dogwood	<i>Cornus drummondii</i>	http://plants.usda.gov/core/profile?symbol=CODR
Flowering dogwood	<i>Cornus florida</i>	http://plants.usda.gov/core/profile?symbol=COFL2
Possumhaw	<i>Ilex decidua</i>	http://plants.usda.gov/core/profile?symbol=ILDE
Red mulberry	<i>Morus rubra</i>	http://plants.usda.gov/core/profile?symbol=MORU2
Hophornbeam	<i>Ostrya virginiana</i>	http://plants.usda.gov/core/profile?symbol=OSVI
Shining/ Flameleaf/ Winged sumac	<i>Rhus copallinum</i>	http://plants.usda.gov/core/profile?symbol=RHCO
Smooth sumac	<i>Rhus glabra</i>	http://plants.usda.gov/core/profile?symbol=RHGL

West Tennessee Native Riparian Plant List

Common Name	Scientific Name	USDA PLANTS Database
SHRUBS		
Hazel alder	<i>Alnus serrulata</i>	http://plants.usda.gov/core/profile?symbol=ALSE2
Indigobush	<i>Amorpha fruticosa</i>	http://plants.usda.gov/core/profile?symbol=AMFR
Red chokeberry	<i>Aronia arbutifolia</i>	http://plants.usda.gov/core/profile?symbol=ARAR7
American beautyberry	<i>Callicarpa americana</i>	http://plants.usda.gov/core/profile?symbol=CAAM2
Buttonbush	<i>Cephalanthus occidentalis</i>	http://plants.usda.gov/core/profile?symbol=CEOC2
Silky dogwood	<i>Cornus amomum</i>	http://plants.usda.gov/core/profile?symbol=COAM2
Hazelnut	<i>Corylus americana</i>	http://plants.usda.gov/core/profile?symbol=COAM3
Hearts-a-bustin	<i>Euonymus americanus</i>	http://plants.usda.gov/core/profile?symbol=EUAM9
Common winterberry	<i>Ilex verticillata</i>	http://plants.usda.gov/core/profile?symbol=ILVE
Virginia sweetspire	<i>Itea virginica</i>	http://plants.usda.gov/core/profile?symbol=ITVI
Spicebush	<i>Lindera benzoin</i>	http://plants.usda.gov/core/profile?symbol=LIBE3
Elderberry	<i>Sambucus nigra L. subsp. canadensis</i>	http://plants.usda.gov/core/profile?symbol=SANIC4
Possumhaw viburnum	<i>Viburnum nudum</i>	http://plants.usda.gov/core/profile?symbol=VINU

West Tennessee Native Riparian Plant List

Common Name	Scientific Name	USDA PLANTS Database
GRASSES and SEDGES		
Big bluestem	<i>Andropogon gerardii</i>	http://plants.usda.gov/core/profile?symbol=ANGE
Splitbeard bluestem	<i>Andropogon ternarius</i>	http://plants.usda.gov/core/profile?symbol=ANTE2
Broomsedge	<i>Andropogon virginicus</i>	http://plants.usda.gov/core/profile?symbol=ANVI2
Giant river cane	<i>Arundinaria gigantea</i>	http://plants.usda.gov/core/profile?symbol=ARGI
Side oats grama	<i>Bouteloua curtipendula</i>	http://plants.usda.gov/core/profile?symbol=BOCU
Sedges	<i>Carex spp.</i>	http://plants.usda.gov/core/profile?symbol=CAREX
River oats	<i>Chasmanthium latifolium</i>	http://plants.usda.gov/core/profile?symbol=CHLA5
Slender wood oats	<i>Chasmanthium laxum</i>	http://plants.usda.gov/core/profile?symbol=CHLA6
Bottlebrush grass	<i>Elymus hystrix</i>	http://plants.usda.gov/core/profile?symbol=ELHY
Virginia wild rye	<i>Elymus virginicus</i>	http://plants.usda.gov/core/profile?symbol=ELVI3
Purple love grass	<i>Eragrostis spectabilis</i>	http://plants.usda.gov/core/profile?symbol=ERSP
Common rush	<i>Juncus effusus</i>	http://plants.usda.gov/core/profile?symbol=JUEF
Pink muhly grass	<i>Muhlenbergia capillaris</i>	http://plants.usda.gov/core/profile?symbol=MUCA2
Switchgrass	<i>Panicum virgatum</i>	http://plants.usda.gov/core/profile?symbol=PAVI2
Silver plume grass	<i>Saccharum alopecuroides</i>	http://plants.usda.gov/core/profile?symbol=SAAL21
Sugarcane plume grass	<i>Saccharum giganteum</i> (<i>Erianthus giganteum</i>)	http://plants.usda.gov/core/profile?symbol=SAGI
Little bluestem	<i>Schizachyrium scoparium</i>	http://plants.usda.gov/core/profile?symbol=SCSC
Green/Dark green bullrush	<i>Scirpus atrovirens</i>	http://plants.usda.gov/core/profile?symbol=SCAT2
Indian grass	<i>Sorghastrum nutans</i>	http://plants.usda.gov/core/profile?symbol=SONU2
Eastern gama grass	<i>Tripsacum dactyloides</i>	http://plants.usda.gov/core/profile?symbol=TRDA3

Middle Tennessee Native Riparian Plant List

Common Name	Scientific Name	
CANOPY		
Red maple	<i>Acer rubrum</i>	http://plants.usda.gov/core/profile?symbol=ACRU
Yellow buckeye	<i>Aesculus flava</i>	http://plants.usda.gov/core/profile?symbol=AEFL
Ohio buckeye	<i>Aesculus glabra</i>	http://plants.usda.gov/core/profile?symbol=AEGL
River birch	<i>Betula nigra</i>	http://plants.usda.gov/core/profile?symbol=BENI
Bitternut hickory	<i>Carya cordiformis</i>	http://plants.usda.gov/core/profile?symbol=CACO15
Pignut hickory	<i>Carya glabra</i>	http://plants.usda.gov/core/profile?symbol=CAGL8
Shellbark hickory	<i>Carya laciniosa</i>	http://plants.usda.gov/core/profile?symbol=CALA21
Shagbark hickory	<i>Carya ovata</i>	http://plants.usda.gov/core/profile?symbol=CAOV2
Mockernut hickory	<i>Carya tomentosa</i>	http://plants.usda.gov/core/profile?symbol=CATO6
Northern catalpa	<i>Catalpa speciosa</i>	http://plants.usda.gov/core/profile?symbol=CASP8
Hackberry	<i>Celtis occidentalis</i>	http://plants.usda.gov/core/profile?symbol=CEOC
Yellowwood	<i>Cladrastis kentuckea</i>	http://plants.usda.gov/core/profile?symbol=CLKE
Common persimmon	<i>Diospyros virginiana</i>	http://plants.usda.gov/core/profile?symbol=DIVI5
American holly	<i>Ilex opaca</i>	http://plants.usda.gov/core/profile?symbol=ILOP
Sweetgum	<i>Liquidambar styraciflua</i>	http://plants.usda.gov/core/profile?symbol=LIST2
Tulip poplar	<i>Liriodendron tulipifera</i>	http://plants.usda.gov/core/profile?symbol=LITU
Blackgum tupelo	<i>Nyssa sylvatica</i>	http://plants.usda.gov/core/profile?symbol=NYSY
Virginia pine	<i>Pinus virginiana</i>	http://plants.usda.gov/core/profile?symbol=PIVI2
Sycamore	<i>Platanus occidentalis</i>	http://plants.usda.gov/core/profile?symbol=PLOC
Eastern cottonwood	<i>Populus deltoides</i>	http://plants.usda.gov/core/profile?symbol=PODE3
Black cherry	<i>Prunus serotina</i>	http://plants.usda.gov/core/profile?symbol=PRSE2
White oak	<i>Quercus alba</i>	http://plants.usda.gov/core/profile?symbol=QUAL
Swamp white oak	<i>Quercus bicolor</i>	http://plants.usda.gov/core/profile?symbol=QUBI
Burr oak	<i>Quercus macrocarpa</i>	http://plants.usda.gov/core/profile?symbol=QUMA2
Chinkapin oak	<i>Quercus muehlenbergii</i>	http://plants.usda.gov/core/profile?symbol=QUMU
Willow oak	<i>Quercus phellos</i>	http://plants.usda.gov/core/profile?symbol=QUPH
Northern red oak	<i>Quercus rubra</i>	http://plants.usda.gov/core/profile?symbol=QURU
Shumard oak	<i>Quercus shumardii</i>	http://plants.usda.gov/core/profile?symbol=QUSH
Black willow	<i>Salix nigra</i>	http://plants.usda.gov/core/profile?symbol=SANI

Middle Tennessee Native Riparian Plant List

Common Name	Scientific Name	USDA PLANTS Database
UNDERSTORY		
Serviceberry	<i>Amelanchier arborea</i>	http://plants.usda.gov/core/profile?symbol=AMAR3
Serviceberry	<i>Amelanchier laevis</i>	http://plants.usda.gov/core/profile?symbol=AMLA
Pawpaw	<i>Asimina triloba</i>	http://plants.usda.gov/core/profile?symbol=ASTR
American hornbeam	<i>Carpinus caroliniana</i>	http://plants.usda.gov/core/profile?symbol=CACA18
Eastern redbud	<i>Cercis canadensis</i>	http://plants.usda.gov/core/profile?symbol=CECA4
Alternate leaf/Pagoda dogwood	<i>Cornus alternifolia</i>	http://plants.usda.gov/core/profile?symbol=COAL2
Roughleaf dogwood	<i>Cornus drummondii</i>	http://plants.usda.gov/core/profile?symbol=CODR
Flowering dogwood	<i>Cornus florida</i>	http://plants.usda.gov/core/profile?symbol=COFL2
Wahoo	<i>Euonymus atropurpureus</i>	http://plants.usda.gov/core/profile?symbol=EUAT5
Carolina buckthorn	<i>Frangula caroliniana</i>	http://plants.usda.gov/core/profile?symbol=FRCA13
Witch hazel	<i>Hamamelis virginiana</i>	http://plants.usda.gov/core/profile?symbol=HAVI4
Possumhaw	<i>Ilex decidua</i>	http://plants.usda.gov/core/profile?symbol=ILDE
Red mulberry	<i>Morus rubra</i>	http://plants.usda.gov/core/profile?symbol=MORU2
Hophornbeam	<i>Ostrya virginiana</i>	http://plants.usda.gov/core/profile?symbol=OSVI
American/Wild plum	<i>Prunus americana</i>	http://plants.usda.gov/core/profile?symbol=PRAM
Chickasaw plum	<i>Prunus angustifolia</i>	http://plants.usda.gov/core/profile?symbol=PRAN3
Hoptree	<i>Ptelea trifoliata</i>	http://plants.usda.gov/core/profile?symbol=PTTR
Smooth sumac	<i>Rhus glabra</i>	http://plants.usda.gov/core/profile?symbol=RHGL
Staghorn sumac	<i>Rhus typhina</i>	http://plants.usda.gov/core/profile?symbol=RHTY
Carolina willow	<i>Salix caroliniana</i>	http://plants.usda.gov/core/profile?symbol=SACA5
Blackhaw viburnum	<i>Viburnum prunifolium</i>	http://plants.usda.gov/core/profile?symbol=VIPR
Rusty blackhaw viburnum	<i>Viburnum rufidulum</i>	http://plants.usda.gov/core/profile?symbol=VIRU

Middle Tennessee Native Riparian Plant List

Common Name	Scientific Name	USDA PLANTS Database
SHRUBS		
Hazel alder	<i>Alnus serrulata</i>	http://plants.usda.gov/core/profile?symbol=ALSE2
Indigobush	<i>Amorpha fruticosa</i>	http://plants.usda.gov/core/profile?symbol=AMFR
Red chokeberry	<i>Aronia arbutifolia</i>	http://plants.usda.gov/core/profile?symbol=ARAR7
Black chokeberry	<i>Aronia melanocarpa</i>	http://plants.usda.gov/core/profile?symbol=ARME6
American beautyberry	<i>Callicarpa americana</i>	http://plants.usda.gov/core/profile?symbol=CAAM2
Sweetshrub	<i>Calycanthus floridus</i>	http://plants.usda.gov/core/profile?symbol=CAFL22
New Jersey tea	<i>Ceanothus americanus</i>	http://plants.usda.gov/core/profile?symbol=CEAM
Buttonbush	<i>Cephalanthus occidentalis</i>	http://plants.usda.gov/core/profile?symbol=CEOC2
Silky dogwood	<i>Cornus amomum</i>	http://plants.usda.gov/core/profile?symbol=COAM2
Hazelnut	<i>Corylus americana</i>	http://plants.usda.gov/core/profile?symbol=COAM3
Leatherwood	<i>Dirca palustris</i>	http://plants.usda.gov/core/profile?symbol=DIPA9
Hearts-a-bustin	<i>Euonymus americanus</i>	http://plants.usda.gov/core/profile?symbol=EUAM9
Wild hydrangea	<i>Hydrangea arborescens</i>	http://plants.usda.gov/core/profile?symbol=HYAR
Oakleaf hydrangea	<i>Hydrangea quercifolia</i>	http://plants.usda.gov/core/profile?symbol=HYQU3
Common winterberry	<i>Ilex verticillata</i>	http://plants.usda.gov/core/profile?symbol=ILVE
Virginia sweetspire	<i>Itea virginica</i>	http://plants.usda.gov/core/profile?symbol=ITVI
Spicebush	<i>Lindera benzoin</i>	http://plants.usda.gov/core/profile?symbol=LIBE3
Ninebark	<i>Physocarpus opulifolius</i>	http://plants.usda.gov/core/profile?symbol=PHOP
Elderberry	<i>Sambucus nigra L. subsp. canadensis</i>	http://plants.usda.gov/core/profile?symbol=SANIC4
Coralberry	<i>Symphoricarpos orbiculatus</i>	http://plants.usda.gov/core/profile?symbol=SYOR

Middle Tennessee Native Riparian Plant List

Common Name	Scientific Name	USDA PLANTS Database
GRASSES and SEDGES		
Big bluestem	<i>Andropogon gerardii</i>	http://plants.usda.gov/core/profile?symbol=ANGE
Splitbeard bluestem	<i>Andropogon ternarius</i>	http://plants.usda.gov/core/profile?symbol=ANTE2
Broomsedge	<i>Andropogon virginicus</i>	http://plants.usda.gov/core/profile?symbol=ANVI2
Giant river cane	<i>Arundinaria gigantea</i>	http://plants.usda.gov/core/profile?symbol=ARGI
Side oats grama	<i>Bouteloua curtipendula</i>	http://plants.usda.gov/core/profile?symbol=BOCU
Sedges	<i>Carex spp.</i>	http://plants.usda.gov/core/profile?symbol=CAREX
Cherokee sedge	<i>Carex cherokeensis</i>	http://plants.usda.gov/core/profile?symbol=CACH3
Frank's sedge	<i>Carex frankii</i>	http://plants.usda.gov/core/profile?symbol=CAFR3
Hop sedge	<i>Carex lupulina</i>	http://plants.usda.gov/core/profile?symbol=CALU4
Fox sedge	<i>Carex vulpinoidea</i>	http://plants.usda.gov/core/profile?symbol=CAVU2
River oats	<i>Chasmanthium latifolium</i>	http://plants.usda.gov/core/profile?symbol=CHLA5
Bottlebrush grass	<i>Elymus hystrix</i>	http://plants.usda.gov/core/profile?symbol=ELHY
Virginia wild rye	<i>Elymus virginicus</i>	http://plants.usda.gov/core/profile?symbol=ELVI3
Purple love grass	<i>Eragrostis spectabilis</i>	http://plants.usda.gov/core/profile?symbol=ERSP
Common rush	<i>Juncus effusus</i>	http://plants.usda.gov/core/profile?symbol=JUEF
Pink muhly grass	<i>Muhlenbergia capillaris</i>	http://plants.usda.gov/core/profile?symbol=MUCA2
Switchgrass	<i>Panicum virgatum</i>	http://plants.usda.gov/core/profile?symbol=PAVI2
Silver plume grass	<i>Saccharum alopecuroides</i>	http://plants.usda.gov/core/profile?symbol=SAAL21
Sugarcane plume grass	<i>Saccharum giganteum (Erianthus giganteum)</i>	http://plants.usda.gov/core/profile?symbol=SAGI
Little bluestem	<i>Schizachyrium scoparium</i>	http://plants.usda.gov/core/profile?symbol=SCSC
Green/Dark green bullrush	<i>Scirpus atrovirens</i>	http://plants.usda.gov/core/profile?symbol=SCAT2
Indian grass	<i>Sorghastrum nutans</i>	http://plants.usda.gov/core/profile?symbol=SONU2
Eastern gama grass	<i>Tripsacum dactyloides</i>	http://plants.usda.gov/core/profile?symbol=TRDA3

East Tennessee Native Riparian Plant List

Common Name	Scientific Name	USDA PLANTS Database
CANOPY		
Red maple	<i>Acer rubrum</i>	http://plants.usda.gov/core/profile?symbol=ACRU
Sugar maple	<i>Acer saccharum</i>	http://plants.usda.gov/core/profile?symbol=ACSA3
Sweet birch	<i>Betula lenta</i>	http://plants.usda.gov/core/profile?symbol=BELE
River birch	<i>Betula nigra</i>	http://plants.usda.gov/core/profile?symbol=BENI
Yellowwood	<i>Cladrastis kentuckea</i>	http://plants.usda.gov/core/profile?symbol=CLKE
Common persimmon	<i>Diospyros virginiana</i>	http://plants.usda.gov/core/profile?symbol=DIVI5
American beech	<i>Fagus grandifolia</i>	http://plants.usda.gov/core/profile?symbol=FAGR
American holly	<i>Ilex opaca</i>	http://plants.usda.gov/core/profile?symbol=ILOP
Sweetgum	<i>Liquidambar styraciflua</i>	http://plants.usda.gov/core/profile?symbol=LIST2
Tulip poplar	<i>Liriodendron tulipifera</i>	http://plants.usda.gov/core/profile?symbol=LITU
Blackgum tupelo	<i>Nyssa sylvatica</i>	http://plants.usda.gov/core/profile?symbol=NYSY
Virginia pine	<i>Pinus virginiana</i>	http://plants.usda.gov/core/profile?symbol=PIVI2
Sycamore	<i>Platanus occidentalis</i>	http://plants.usda.gov/core/profile?symbol=PLOC
Black cherry	<i>Prunus serotina</i>	http://plants.usda.gov/core/profile?symbol=PRSE2
Swamp white oak	<i>Quercus bicolor</i>	http://plants.usda.gov/core/profile?symbol=QUBI
Swamp chestnut oak	<i>Quercus michauxii</i>	http://plants.usda.gov/core/profile?symbol=QUMI
Chinkapin oak	<i>Quercus muhlenbergii</i>	http://plants.usda.gov/core/profile?symbol=QUMU
Shumard oak	<i>Quercus shumardii</i>	http://plants.usda.gov/core/profile?symbol=QUSH
Black willow	<i>Salix nigra</i>	http://plants.usda.gov/core/profile?symbol=SANI
Sassafras	<i>Sassafras albidum</i>	http://plants.usda.gov/core/profile?symbol=SAAL5

East Tennessee Native Riparian Plant List

Common Name	Scientific Name	USDA PLANTS Database
UNDERSTORY		
Serviceberry	<i>Amelanchier arborea</i>	http://plants.usda.gov/core/profile?symbol=AMAR3
Serviceberry	<i>Amelanchier laevis</i>	http://plants.usda.gov/core/profile?symbol=AMLA
American hornbeam	<i>Carpinus caroliniana</i>	http://plants.usda.gov/core/profile?symbol=CACA18
Eastern redbud	<i>Cercis canadensis</i>	http://plants.usda.gov/core/profile?symbol=CECA4
Alternate leaf/Pagoda dogwood	<i>Cornus alternifolia</i>	http://plants.usda.gov/core/profile?symbol=COAL2
Flowering dogwood	<i>Cornus florida</i>	http://plants.usda.gov/core/profile?symbol=COFL2
Witch hazel	<i>Hamamelis virginiana</i>	http://plants.usda.gov/core/profile?symbol=HAVI4
Red mulberry	<i>Morus rubra</i>	http://plants.usda.gov/core/profile?symbol=MORU2
Hophornbeam	<i>Ostrya virginiana</i>	http://plants.usda.gov/core/profile?symbol=OSVI
American/Wild plum	<i>Prunus americana</i>	http://plants.usda.gov/core/profile?symbol=PRAM
Rosebay/Great laurel rododendron	<i>Rhododendron maximum</i>	http://plants.usda.gov/core/profile?symbol=RHMA4
Smooth sumac	<i>Rhus glabra</i>	http://plants.usda.gov/core/profile?symbol=RHGL
Staghorn sumac	<i>Rhus typhina</i>	http://plants.usda.gov/core/profile?symbol=RHTY
Rusty blackhaw viburnum	<i>Viburnum rufidulum</i>	http://plants.usda.gov/core/profile?symbol=VIRU

East Tennessee Native Riparian Plant List

Common Name	Scientific Name	USDA PLANTS Database
SHRUBS		
Hazel alder	<i>Alnus serrulata</i>	http://plants.usda.gov/core/profile?symbol=ALSE2
Indigobush	<i>Amorpha fruticosa</i>	http://plants.usda.gov/core/profile?symbol=AMFR
Red chokeberry	<i>Aronia arbutifolia</i>	http://plants.usda.gov/core/profile?symbol=ARAR7
American beautyberry	<i>Callicarpa americana</i>	http://plants.usda.gov/core/profile?symbol=CAAM2
Cinnamon clethra	<i>Clethra acuminata</i>	http://plants.usda.gov/core/profile?symbol=CLAC3
Silky dogwood	<i>Cornus amomum</i>	http://plants.usda.gov/core/profile?symbol=COAM2
Hazelnut	<i>Corylus americana</i>	http://plants.usda.gov/core/profile?symbol=COAM3
Wild hydrangea	<i>Hydrangea arborescens</i>	http://plants.usda.gov/core/profile?symbol=HYAR
Common winterberry	<i>Ilex verticillata</i>	http://plants.usda.gov/core/profile?symbol=ITVI
Spicebush	<i>Lindera benzoin</i>	http://plants.usda.gov/core/profile?symbol=LIBE3
Elderberry	<i>Sambucus nigra L. subsp. canadensis</i>	http://plants.usda.gov/core/profile?symbol=SANIC4
Mapleleaf viburnum	<i>Viburnum acerifolium</i>	http://plants.usda.gov/core/profile?symbol=VIAC

East Tennessee Native Riparian Plant List

Common Name	Scientific Name	USDA PLANTS Database
GRASSES and SEDGES		
Big bluestem	<i>Andropogon gerardii</i>	http://plants.usda.gov/core/profile?symbol=ANGE
Splitbeard bluestem	<i>Andropogon ternarius</i>	http://plants.usda.gov/core/profile?symbol=ANTE2
Broomsedge	<i>Andropogon virginicus</i>	http://plants.usda.gov/core/profile?symbol=ANVI2
Giant river cane	<i>Arundinaria gigantea</i>	http://plants.usda.gov/core/profile?symbol=ARGI
Side oats grama	<i>Bouteloua curtipendula</i>	http://plants.usda.gov/core/profile?symbol=BOCU
Sedges	<i>Carex spp.</i>	http://plants.usda.gov/core/profile?symbol=CAREX
Fox sedge	<i>Carex vulpinoidea</i>	http://plants.usda.gov/core/profile?symbol=CAVU2
River oats	<i>Chasmanthium latifolium</i>	http://plants.usda.gov/core/profile?symbol=CHLA5
Bottlebrush grass	<i>Elymus hystrix</i>	http://plants.usda.gov/core/profile?symbol=ELHY
Virginia wild rye	<i>Elymus virginicus</i>	http://plants.usda.gov/core/profile?symbol=ELVI3
Purple love grass	<i>Eragrostis spectabilis</i>	http://plants.usda.gov/core/profile?symbol=ERSP
Common rush	<i>Juncus effusus</i>	http://plants.usda.gov/core/profile?symbol=JUEF
Pink muhly grass	<i>Muhlenbergia capillaris</i>	http://plants.usda.gov/core/profile?symbol=MUCA2
Switchgrass	<i>Panicum virgatum</i>	http://plants.usda.gov/core/profile?symbol=PAVI2
Silver plume grass	<i>Saccharum alopecuroides</i>	http://plants.usda.gov/core/profile?symbol=SAAL21
Sugarcane plume grass	<i>Saccharum giganteum</i> (<i>Erianthus giganteum</i>)	http://plants.usda.gov/core/profile?symbol=SAGI
Little bluestem	<i>Schizachyrium scoparium</i>	http://plants.usda.gov/core/profile?symbol=SCSC
Green/Dark green bullrush	<i>Scirpus atrovirens</i>	http://plants.usda.gov/core/profile?symbol=SCAT2
Indian grass	<i>Sorghastrum nutans</i>	http://plants.usda.gov/core/profile?symbol=SONU2
Eastern gama grass	<i>Tripsacum dactyloides</i>	http://plants.usda.gov/core/profile?symbol=TRDA3

Descriptive Native Plant List Legend

Height of plant in feet

Light Requirements

F = full sunlight

P = partial shade

S = shade

Soil Moisture

H = hydric, wet, plants periodically or often inundated by water

M = mesic, moist, adequate soil moisture retention year-round

S = sub-xeric, moist to dry, seasonally moist, periodically dry

X = xeric, dry and drought resistant, little moisture retention, excessively drained

Soil pH

A = acidic (slightly acidic to strongly acidic)

B = basic (tolerate alkaline conditions)

Wildlife Benefit

The benefit may be as a food source and/or cover or home for the animal.

B = Bird (song birds, waterfowl)

SM = Small Mammal (squirrels, chipmunks)

LM = Large Mammal (deer)

Aesthetics

Description of beauty of plant that may include flowers, bark, leaf color, or plant structure.

Common Name	Scientific Name	Height	Light			Soil Moisture					Soil pH			Wildlife Benefit			Aesthetics	
			F	P	S	H	M	S	X	B	A	B	SM	LM				
CANOPY																		
Red maple	<i>Acer rubrum</i>	50-75'	•	•		•	•	•							•	•	•	Red twigs and red flowers in early spring; beautiful fall foliage
Sugar maple	<i>Acer saccharum</i>	70-100'		•	•		•	•								•		Yellow and orange fall foliage
Yellow buckeye	<i>Aesculus flava</i>	60-75'	•	•			•	•							•	•		Yellow flowers in spring; orange fall foliage
Ohio buckeye	<i>Aesculus glabra</i>	30-50'		•	•		•	•								•		Flowers in spring
Sweet birch	<i>Betula lenta</i>	40-50'	•	•			•	•								•		Yellow fall foliage
River birch	<i>Betula nigra</i>	40-70'	•	•		•										•		Yellow fall foliage; bronze exfoliating bark.
Bitternut hickory	<i>Carya cordiformis</i>	50-80'	•	•			•	•								•		Bright sulfur yellow buds in spring; rich golden colored leaves in fall; native to bottomlands, floodplains and moist slopes
Pignut hickory	<i>Carya glabra</i>	50-80'	•	•			•	•								•		Yellow fall foliage
Pecan	<i>Carya illinoensis</i>	70-100'	•	•			•	•								•		Attracts butterflies
Shellbark hickory	<i>Carya laciniosa</i>	60-90'	•	•			•									•		Bark peels away in strips
Shagbark hickory	<i>Carya ovata</i>	70-80'	•	•			•	•								•		Exfoliating bark that curls off in long, loose strips; rich, golden fall foliage
Mockernut hickory	<i>Carya tomentosa</i>	60-80'	•	•			•	•								•		Attracts butterflies; golden-yellow fall foliage
Northern catalpa	<i>Catalpa speciosa</i>	40-60'	•	•			•	•										Attracts butterflies and bees; white flowers with purplish and yellow spots or streaks in late spring to early summer

Common Name	Scientific Name	Height	Light			Soil Moisture				Soil pH			Wildlife Benefit			Aesthetics
			F	P	S	H	M	S	X	B	A	B	SM	LM		
CANOPY																
Yellowwood	<i>Cladrastis kentuckea</i>	30-50'	•	•	•		•									Tennessee's Bicentennial Tree; beautiful panicles of snow white flowers that hang from the branch tips in spring, often compared to wisteria blooms; yellow or orange fall foliage
Common persimmon	<i>Diospyros virginiana</i>	35-60'	•	•			•						•			Fragrant white, bell-shaped flowers; rich yellowish or reddish purple foliage in fall
American beech	<i>Fagus grandifolia</i>	50-70'	•	•			•						•			Beautiful golden bronze fall foliage
American holly	<i>Ilex opaca</i>	15-30'	•	•			•						•			Broadleaf evergreen with bright red berries in winter
Sweetgum	<i>Liquidambar styraciflua</i>	60-85'	•	•			•						•			Beautiful fall color
Tulip poplar	<i>Liriodendron tulipifera</i>	70-90'	•	•			•						•			Tennessee state tree; large colorful flowers in spring; yellow fall foliage
Blackgum tupelo	<i>Nyssa sylvatica</i>	30-60'	•	•	•								•			Red foliage in early fall
Virginia pine	<i>Pinus virginiana</i>	50-75'	•	•									•			
Sycamore	<i>Platanus occidentalis</i>	75-100'	•	•			•						•			Attractive exfoliating bark
Eastern cottonwood	<i>Populus deltoides</i>	80-100'	•										•			Rapid growth rate provides quick shade
Black cherry	<i>Prunus serotina</i>	50-75'	•	•			•						•			White flowers in spring; yellow to wine-red fall foliage.
White oak	<i>Quercus alba</i>	80-100'	•	•									•			Bronze to red fall foliage
Swamp white oak	<i>Quercus bicolor</i>	45-65'	•	•			•						•			Yellow, with occasional red-purple fall foliage
Overcup oak	<i>Quercus lyrata</i>	55-95'	•										•			Yellow-brown fall foliage
Burr oak	<i>Quercus macrocarpa</i>	70-85'	•	•									•			Attractive form with spreading branches

Common Name	Scientific Name	Height	Light			Soil Moisture				Soil pH			Wildlife Benefit			Aesthetics	
			F	P	S	H	M	S	X	B	A	B	SM	LM			
CANOPY																	
Swamp chestnut oak	<i>Quercus michauxii</i>	48-100'	•	•			•	•			•	•	•	•	•	•	Yellow to vibrant red fall foliage
Chinkapin oak	<i>Quercus muehlenbergii</i>	60-80'	•	•			•	•			•	•	•	•	•	•	Attractive fall foliage
Nuttall oak	<i>Quercus nuttallii</i>	50-75'	•	•		•	•				•	•	•	•	•	•	Red to orange red late-fall foliage
Cherrybark oak	<i>Quercus pagoda</i>	70-80'	•	•			•	•				•	•	•	•	•	Shade tree and fast-growing oak
Willow oak	<i>Quercus phellos</i>	50-70'	•	•			•	•				•	•	•	•	•	Russet-red fall foliage; commonly planted as ornamental and shade tree
Northern red oak	<i>Quercus rubra</i>	60-85'	•	•								•	•	•	•	•	Fast grower; red fall foliage
Shumard oak	<i>Quercus shumardii</i>	50-80'	•	•			•	•				•	•	•	•	•	Fast grower and good shade tree; deep orange-red fall foliage
Black willow	<i>Salix nigra</i>	30-60'	•	•		•						•				•	Shrubby-looking tree
Bald cypress	<i>Taxodium distichum</i>	40-100'	•	•		•											Deciduous conifer; soft brown fall foliage; commonly used as ornamental tree
Sassafras	<i>Sassafras albidum</i>	30-60'	•	•		•						•	•	•	•	•	Small yellow flowers; yellow to purple-red fall foliage

Common Name	Scientific Name	Height	Light			Soil Moisture				Soil pH			Wildlife Benefits			Aesthetics
			F	P	S	H	M	S	X	A	B	LM	B	SM	LM	
UNDERSTORY																
Red buckeye	<i>Aesculus pavia</i>	10-25'	•	•	•		•							•		Bright red flowers in April/May attract hummingbirds
Common Serviceberry	<i>Amelanchier arborea</i>	15-25'	•	•			•							•		Showy and fragrant flowers; beautiful fall foliage
Allegheny Serviceberry	<i>Amelanchier laevis</i>	25-40'	•	•			•							•		Showy and fragrant flowers; dark purple fruit; beautiful fall foliage
Pawpaw	<i>Asimina triloba</i>	15-20'	•	•			•							•		Yellow fall foliage
American hornbeam	<i>Carpinus caroliniana</i>	25-40'		•			•							•		Smooth, blue-gray bark and sinuous, rippled trunks that resemble muscled arms; yellow, orange, scarlet and sometimes maroon fall foliage
Eastern redbud	<i>Cercis canadensis</i>	20-30'	•	•			•							•		Pink flowers in spring before leaves come out
Alternate leaf / Pagoda dogwood	<i>Cornus alternifolia</i>	10-25'	•	•			•							•		Creamy white flowers; reddish, purple berries
Roughleaf dogwood	<i>Cornus drummondii</i>	6-15'	•	•			•							•		Large showy clusters of tiny flowers; purplish-red fall foliage
Flowering dogwood	<i>Cornus florida</i>	12-30'	•	•			•							•		White or pink flowers in April/May; egg-shaped, bright scarlet-red berries in fall; purplish-red fall foliage
Burningbush, Wahoo	<i>Euonymus atropurpureus</i>	20-25'	•	•			•									Red fall foliage; crimson pods split in mid-autumn to reveal scarlet-coated seeds which hang on far into winter
Carolina buckthorn	<i>Frangula caroliniana (Rhamnus caroliniana)</i>	12-15'		•										•		Bright red fruit in summer that turns black in fall
Witch hazel	<i>Hamamelis virginiana</i>	8-20'		•										•		Unusual yellow flowers in fall; yellow fall foliage
Possumhaw	<i>Ilex decidua</i>	12-20'	•	•			•							•		Deciduous holly; brilliant red fruits

Common Name	Scientific Name	Height	Light			Soil Moisture				Soil pH			Wildlife Benefits			Aesthetics	
			F	P	S	H	M	S	X	A	B	LM	B	SM	LM		
UNDERSTORY																	
Red mulberry	<i>Morus rubra</i>	35-50'	•	•			•	•		•	•	•	•	•			Dark reddish purple berries, resembling a blackberry in mid-summer
Hophornbeam	<i>Ostrya virginiana</i>	20-50'	•	•	•		•	•		•	•	•	•	•			Retains coppery-tan leaves well into winter
American/ Wild plum	<i>Prunus americana</i>	Up to 15'	•	•			•	•		•	•	•	•	•			
Chickasaw plum	<i>Prunus angustifolia</i>	5-15'	•	•			•	•		•	•	•	•	•			White flowers are attractive and fragrant in spring
Hoptree	<i>Ptelea trifoliata</i>	15-20'	•	•	•		•	•		•	•	•	•	•			Attracts butterflies; ornamental fruits
Rosebay/Great laurel rhododendron	<i>Rhododendron maximum</i>	4-15'	•	•	•		•	•		•	•	•	•	•			Evergreen with large, bell-shaped, white to purplish-pink, spotted flowers that appear in large terminal clusters
Shining/Flameleaf/Winged sumac	<i>Rhus copallinum</i>	Up to 10'	•							•							Brilliant red fall foliage
Smooth sumac	<i>Rhus glabra</i>	9-15'	•	•						•	•	•	•	•			Colorful fall foliage
Staghorn sumac	<i>Rhus typhina</i>	15-30'	•							•	•	•	•	•			Bright red berries in erect, pyramidal clusters and colorful fall foliage
Carolina willow, Coastal Plain Willow	<i>Salix caroliniana</i>	Up to 20'	•	•			•			•				•			
Blackhaw viburnum	<i>Viburnum prunifolium</i>	8-15'	•	•						•	•	•	•	•			White flower clusters; reddish-purple fall foliage
Rusty blackhaw viburnum	<i>Viburnum rufidulum</i>	Up to 18'		•										•			Excellent fall hues of red, lavender, pink, and orange

Common Name	Scientific Name	Height	Light			Soil Moisture				Soil pH			Wildlife Benefit			Aesthetics
			F	P	S	H	M	S	X	B	A	B	SM	LM		
SHRUB																
Hazel alder	<i>Alnus serrulata</i>	10-20'	•			•	•				•	•	•	•		Yellow to red fall foliage
False Indigo bush	<i>Amorpha fruticosa</i>	6-10'	•	•			•	•			•	•				Attracts bees and butterflies; purple to dark blue flowers in spring
Red chokeberry	<i>Aronia arbutifolia</i>	6-11'	•	•			•	•			•					Reddish-brown exfoliating bark; red fall foliage
Black chokeberry	<i>Aronia melanocarpa</i>	3-6'	•	•		•	•				•					White flowers in May; black to purplish-black berries; good fall foliage
American beautyberry	<i>Callicarpa americana</i>	3-6'	•	•			•	•			•	•	•	•		Lavender pink flowers in summer; beautiful magenta berry-like fruit persists through winter
Sweetshrub	<i>Calycanthus floridus</i>	6-9'	•	•			•						•			Sweet-scented purple-brown unique, oddly shaped flowers
New Jersey tea	<i>Ceanothus americanus</i>	2-3'	•	•			•	•			•	•	•			Attracts butterflies; white flowers
Buttonbush	<i>Cephalanthus occidentalis</i>	5-12'	•			•					•					Attracts butterflies; creamy white flowers
Cinnamon clethra, Mountain sweetpepperbush	<i>Clethra acuminata</i>	8-15'	•	•				•					•			Attracts bees; reddish-brown exfoliating bark
Silky dogwood	<i>Cornus amomum</i>	6-12'	•	•		•	•				•	•	•	•		Attractive white flowers; blue fruits
Hazelnut	<i>Corylus americana</i>	5-12'		•	•		•	•			•	•	•	•		Attracts butterflies
Leatherwood	<i>Dirca palustris</i>	3-6'		•							•					Has attractive bell-shaped flowers in pendulous clusters and leaves which turn a unique shade of soft yellow in fall
Hearts-a-bustin	<i>Euonymus americanus</i>	4-6'		•	•			•			•	•	•	•		Bright orange-red fruit display after the warty, pinkish capsules open in fall
Wild hydrangea	<i>Hydrangea arborescens</i>	3-6'		•							•	•				Large clusters of white flowers; light yellow fall foliage

Common Name	Scientific Name	Height	Light			Soil Moisture				Soil pH			Wildlife Benefit			Aesthetics
			F	P	S	H	M	S	X	B	A	B	SM	LM		
SHRUB																
Oakleaf hydrangea	<i>Hydrangea quercifolia</i>	6-8'	•	•		•	•	•			•					Large clusters of white flowers; purple-red fall foliage
Common winterberry	<i>Ilex verticillata</i>	6-10'		•	•	•							•			A deciduous holly; red berries persist into January
Virginia sweetspire	<i>Itea virginica</i>	4-10'	•	•	•	•	•	•						•		Fragrant showy white flowers; reddish fall foliage
Spicebush	<i>Lindera benzoin</i>	6-12'		•	•											Yellow flowers; yellow fall foliage; bright red fruit
Ninebark	<i>Physocarpus opulifolius</i>	5-10'	•	•		•	•	•								Attracts bees and butterflies; has showy flowers
American Black Elderberry	<i>Sambucus nigra</i> L. <i>subsp. canadensis</i>	5-12'	•	•												Attracts butterflies; White flowers in large clusters
Coralberry	<i>Symphoricarpos orbiculatus</i>	2-5'	•	•		•	•	•								greenish white to pink flowers; coral red to purplish globular berries, 1/6 - 1/8 inch across, in October and persisting into late winter
Mapleleaf viburnum	<i>Viburnum acerifolium</i>	3-6'	•	•		•										creamy white flowers; clusters of red to bluish black, oval-shaped, 1/3 inch long berries in fall.
Possumhaw viburnum	<i>Viburnum nudum</i>	12-20'		•	•											Reddish fall foliage; lots of small white flowers, waxy green leaf in summer

Common Name	Scientific Name	Height	Light			Soil Moisture					Soil pH			Wildlife Benefit			Aesthetics
			F	P	S	H	M	S	X	B	A	B	SM	LM			
GRASSES and SEDGES																	
Big bluestem	<i>Andropogon gerardii</i>	4-8'	•				•	•				•	•		•		Reddish to purple brown in fall
Splitbeard bluestem	<i>Andropogon ternarius</i>	2-4'	•	•			•	•									Attractive silvery white seed tufts
Broomsedge	<i>Andropogon virginicus</i>	2-4'	•	•			•	•							•		Yellow flower and tawny brown color in fall
Giant river cane	<i>Arundinaria gigantea</i> <i>spp. gigantea</i>	3-20'	•	•	•		•	•							•		Can form large colonies
Side oats grama	<i>Bouteloua curtipendula</i>	1-2'	•	•			•	•							•		Purplish red flowers in late summer
Sedges	<i>Carex spp.</i>	3-5'	•				•										
Cherokee sedge	<i>Carex cherokeensis</i>	1-1.5'		•			•	•									Attractive pendulous flower/seed stalks in late spring
Frank's sedge	<i>Carex frankii</i>	1-2.5'	•	•			•	•									Attracts butterflies
Hop sedge	<i>Carex lupulina</i>	1-4'	•	•			•	•									Attracts butterflies
Fox sedge	<i>Carex vulpinoidea</i>	1-3'	•	•			•					•					Seedheads spray out attractively from the center of the clump, looking like a fox's tail
River oats, Indian woodoats	<i>Chasmanthium latifolium</i>	2.5-4'	•	•			•	•									Provides excellent contrast and texture almost year-round to the planting area
Slender woodoats	<i>Chasmanthium laxum</i>	2-3'		•	•		•	•									Arrowhead-shaped, persistent seed heads
Bottlebrush grass	<i>Elymus hystrix</i>	2-3'	•	•			•	•									Attracts butterflies
Virginia wild rye	<i>Elymus virginicus</i>	3-4'	•	•			•	•									Attracts butterflies
Purple love grass	<i>Eragrostis spectabilis</i>	1-2'	•	•			•	•									Fine-textured stiff flowerhead appears like reddish purple clouds
Common rush	<i>Juncus effusus</i>	2-4'	•				•	•									

Common Name	Scientific Name	Height	Light			Soil Moisture				Soil pH			Wildlife Benefit			Aesthetics
			F	P	S	H	M	S	X	B	A	B	SM	LM		
GRASSES and SEDGES																
Pink muhly grass	<i>Muhlenbergia capillaris</i>	2-3'	•	•			•	•			•					Blooms in fall, pink to pinkish red flowers
Switchgrass	<i>Panicum virgatum</i>	3-6'	•	•			•	•					•			Attracts butterflies; blooms late summer into fall, pink flowers
Silver plume grass	<i>Saccharum alopecuroides</i>	5-6'	•	•			•	•								Produces a large, rosy copper plume in the fall that fades to a silvery peach
Sugarcane plume grass	<i>Saccharum giganteum</i> (<i>Erianthus giganteum</i>)	9'	•	•			•	•								Large, fluffy, terminal panicle of reddish-peach to silvery white seedheads. Foliage turns orange red and fades to straw color in winter.
Little bluestem	<i>Schizachyrium scoparium</i>	2-4'	•	•				•								Bluish cast in summer and turns orange-red in fall
Green bullrush	<i>Scirpus atrovirens</i>	2-5'	•	•			•	•								
Indian grass	<i>Sorghastrum nutans</i>	3-7'	•	•				•								Attracts butterflies; Rich gold and purple sprays of flowers in fall
Eastern gama grass	<i>Tripsacum dactyloides</i>	4-8'	•	•				•								Purple and orange flowers

The Tennessee Urban Riparian Buffer Handbook Series

This handout is one of a series of supporting appendices to the **Tennessee Urban Riparian Buffer Handbook**. To download go to: <http://tn.gov/agriculture/topic/ag-forests-urban>

- A. The Tennessee Urban Riparian Buffer
- B. Tennessee Riparian Buffer Site Assessment
- C. Creating a Tennessee Urban Riparian Buffer
- D. Tennessee Native Riparian Plants List
- E. The Threat of Invasive Plants to Tennessee Urban Riparian Buffers
- F. Organizing and Conducting a Riparian Buffer Community Planting
- G. Properly Installing Plants: How to Plant Trees and Shrubs

This page intentionally left blank

E. The Threat of Invasive Plants to Tennessee Urban Riparian Buffers

Native plants are those that naturally occur in a region or habitat and have co-evolved over geologic time with other plants and animals to develop specialized ecological relationships.

Riparian buffers are increasingly being encroached upon by nonnative plants that are invasive (see Figures E-1& E-2). This is partially due to buffers being located along waterways that attract more seed-carrying wildlife. However, invasive plants also tend to establish in disrupted habitats. Buffers in many urban areas have commonly had their structure and composition dramatically altered, providing a prime area for invasive plants to establish.

Impacts of Nonnative, Invasive Plants

A healthy riparian buffer contains native plants that create an ecologically balanced forest community. This balance is disrupted when nonnative plants predominate and the impacts can be extensive.

- 1. Native plants are crowded out:** Buffers provide food, cover, water and breeding areas for a wide range of birds and other wildlife. Invasive plants can reduce host plants needed for local fauna, reducing food sources and breeding grounds.
- 2. Dense subcanopy layers are created:** The healthy mix of subcanopy species created by a native plant community is replaced by one or two invasive species. This change in subcanopy structure dramatically reduces habitat types including those needed by birds for safe nesting.
- 3. Dense physical and visual barriers are created:** Urban riparian buffers serve as corridors, allowing for movement of wildlife. This is disrupted with thickets of invasive plants. It can also present problems for upland adjacent property owners who wish to visually or physically access the waterway.

Two Nonnative Plants that Commonly Invade Riparian Buffers



Figure E-1. Chinese privet and a closeup of its leaves and berries



Figure E-2. Bush honeysuckle (*Lonicera spp.*) and a close-up of its leaves and berries.

Invasive plant impacts can be worsened when a buffer is limited in width. In this situation, the light along the buffer edges can easily penetrate throughout the vegetation, disrupting the canopy layers from shading out unwanted plants. This phenomenon is referred to as the “edge effect” and can be reduced by planting wider buffers that result in more natural forest layers.



Figure E-3. A healthy buffer containing native plants that creates a multi-layer forest strata

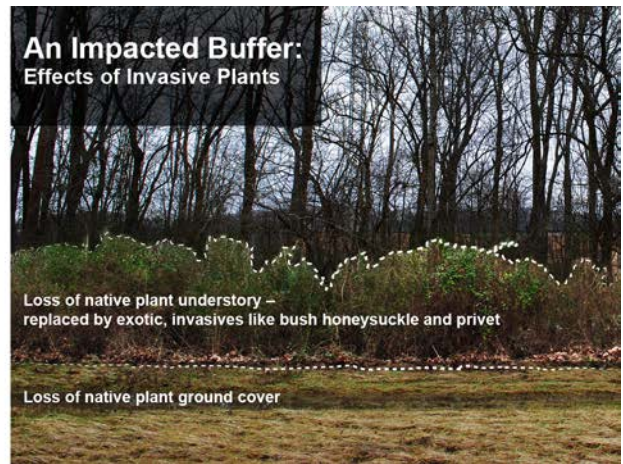

Figure E-4. A buffer impacted by noninvasive plants; forest layers are lost, reducing habitat and food sources for native animals

Approaches to Removing Invasive Plants

There are a range of control methods for invasive species, but care should be taken when selecting one to ensure it is appropriate for the targeted plant species. The Nature Conservancy has an online “weed control” handbook that offers a wealth of information on the general approaches that can be taken to for invasive removal, <http://www.invasive.org/gist/handbook.html>.

Additional resources on general and invasive plant-specific removal strategies can be found in the Supplementary Resources section in the **Tennessee Urban Riparian Buffer Handbook**.

Two commonly used invasive plant removal methods are manual or mechanical control and cut/stump herbicide treatment:

Manual or Mechanical Control: Manual or mechanical control can include hand pulling or using a pulling-tool such as a Weed Wrench™.

- Hand pulling can be effective on some young shrubs and tree saplings, but care should be taken not to break off the stem and leave root fragments that can resprout.
- A Weed Wrench™ has a specialized claw to grip the stem and provides a lever to pull the plant up and out. There are varying sizes of weed wrenches based on the stem size. The challenge with using weed wrenches in riparian areas is that they work best on firm ground and not soft substrate as is often the case in these areas. Weed Wrenches are no longer being manufactured but used ones are available online and similar alternatives are now on the market. Local municipal departments or Extension offices may have them available for loan.



Figure E-5. Weed Wrench™

It is important to not mechanically remove plants immediately adjacent to a waterway when the plants' root systems are serving to stabilize the waterway's bank. In situations like this, it may be necessary to keep the plant pruned back until the installed natives have matured enough to provide the needed bank stability.

Cut Stump Herbicide Treatment: This method involves cutting the plants' stems and applying an herbicide to each stem by spraying or painting the stems' end (see Figure E-6).

The appropriate herbicide must be selected. For example, with Chinese privet, a 25 percent concentrate of glyphosphate may be used. As with all herbicide applications, all application directions should be strictly followed.

The best time to apply an herbicide is determined by the physiology of the plant, so it is important to reference plant-specific guidelines. A dye may be mixed with the herbicide to ensure the herbicide is being appropriately placed and to easily see which plants have been treated.



Figure E-6. Application of herbicide with dye to tree stump

The Nature Conservancy's Weed Control Handbook provides directions to make an inexpensive PVC herbicide applicator (see Figure E-7). The sponge-tip applicator stores herbicide in its PVC pipe chassis (A). A ball valve (B) supplies the herbicide to the sponge reservoir (C). Herbicide in this small chamber (C) leaks through a flow restricting drip plate (D), and moistens the applicator sponge (E). When the sponge reservoir is depleted of herbicide during use, turning the valve will recharge it. Rubber gaskets (shown in grey) let the wand be refilled or disassembled for cleaning.

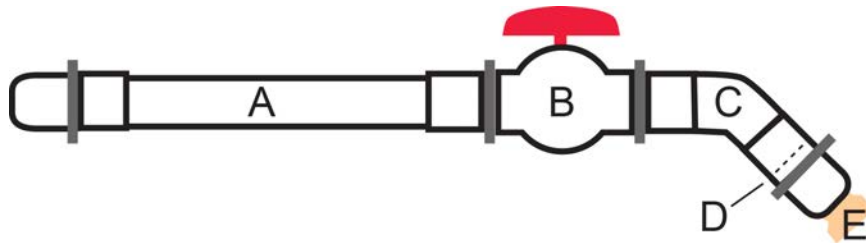

Figure E-7. Le wand, <http://www.invasive.org/gist/tools/wand.html>

The Tennessee Urban Riparian Buffer Handbook Series

This handout is one of a series of supporting appendices to the **Tennessee Urban Riparian Buffer Handbook**. To download go to: <http://tn.gov/agriculture/topic/ag-forests-urban>

- A. The Tennessee Urban Riparian Buffer
- B. Tennessee Riparian Buffer Site Assessment
- C. Creating a Tennessee Urban Riparian Buffer
- D. Tennessee Native Riparian Plants List
- E. The Threat of Invasive Plants to Tennessee Urban Riparian Buffers
- F. Organizing and Conducting a Riparian Buffer Community Planting
- G. Properly Installing Plants: How to Plant Trees and Shrubs

F. Organizing and Conducting a Riparian Buffer Community Planting

Conducting community planting days can be great fun and rewarding as volunteers come together for the camaraderie and to make a difference in their community. The planning process can also be fruitful as partnerships are built and resources are shared. Following are steps to organizing and conducting a planting. They are not a one-size-fits all and will need to be adapted to the needs of your community and partners.

1. Consider potential project partners who can assist in identifying possible planting sites and provide resources (e.g., plant knowledge; loan tools). These may include your local:

- municipal stormwater program.
- county Extension office.
- NRCS district office.
- watershed group.

2. Conduct initial partner planning meeting to discuss:

- project goals (individual and mutual) and timeframe;
- candidate planting sites;
- potential sources of project funding if not secured (A project may have to be delayed up to a year if supporting grant funds must be secured);
- and a date to conduct a field outing to assess potential buffer sites.

3. Select your buffer site

- Conduct a “windshield survey” in your community, looking for riparian areas devoid of vegetation. Consider using on-line maps (e.g., Google Earth) to help.
- Identify the landowner of potential planting sites and discuss with them their interest in participating in a planting project and their willingness to protect the site if planted.
- Obtain landowner’s approval to go onsite to conduct the initial buffer prioritization assessment in order to rank and select a site (see Appendix B).

4. Create a buffer plan (See Appendix C)

- Conduct a site inventory.
- Create a planting sketch including features affecting the planting area size.
- Determine planting quantities.
- Identify mix of desired plant species.

5. Check on sources of seedlings and B&B/container trees and shrubs.

- Check cost, availability and shipping dates of bare root seedlings from on-line nurseries.
- Check with local nurseries and garden stores to find desired B&B/container trees and shrubs. This should be done far enough in advance (e.g., one month) to ensure desired stock can be found. Often nurseries and garden stores will let you purchase in advance and will hold the stock, particularly if it is for a community planting event.

6. Select a tentative planting date at least three months in advance

- Best time of year for planting container or B&B plants is from November through March, and for bare root seedlings is January through March when they are dormant
- Check calendars to ensure that other events will not conflict with your targeted volunteer source.
- Identify a rain date.

7. Identify number of needed volunteers and supervisors. Consider:

- Number of plants to be installed and the length of planting event
- About one supervisor per 10 volunteers

**Estimated Number of Volunteers Needed
for Planting Bare Root Seedlings**

# of Volunteers or Volunteer Teams	Bare Root Seedlings Installed	
	Per Hour	Per 3 Hours
10	60	180
15	90	270
30	180	540

8. Develop a draft volunteer recruitment strategy

- Consider key groups for obtaining volunteers (scouts, watershed and conservation groups, civic groups, churches and home school networks) and/or whether the event will be promoted community wide.
- Identify the most effective ways of reaching candidate volunteers:
 - » websites
 - » social media
 - » listserves
 - » on-line community calendars
 - » flyers (see example on page F-9)

- Identify the event’s contact person who can answer event questions and interact with the media.
- Determine if pre-registration for the event is required and how registration will be conducted (via e-mail, telephone or on-line registration).
- Provide volunteer expectations (e.g., bring shovel) in marketing materials or in a follow up participation confirmation call or e-mail.
- Consider making a real-estate size sign that promotes the upcoming planting and place it at the buffer site two weeks in advance. This will also notify the adjacent landowners of the pending planting installation (see example page F-10).

9. Conduct partner planning meeting

- Finalize planting date.
- Discuss draft volunteer recruitment strategies given needed number of volunteers. Seek input and contributions each partner can make.
- Discuss needed supplies and potential sources.
- Finalize planting plan budget including costs of plants, materials for recruiting volunteers and day-of-event supplies. Often when multiple partners are involved the costs can be shared or items/services can be donated (e.g. copying of flyers).

10. Order plants

- For bare root seedlings, order early in nursery’s shipping period to ensure availability.
- Ask for delivery the week before planting. Nurseries typically dig the seedlings right before packaging for shipping.
- Call nursery two weeks before delivery to confirm delivery date.

11. Implement volunteer recruitment strategy

12. Prepare the site for buffer installation

- Call Tennessee811 at least a week before site preparation day to ensure utility lines are marked.
- Mark site boundaries with WHITE flagging, paint or stakes.
- Locate and remove debris (e.g., washed up trash, branches)
- Mark any areas of safety concern (e.g., using flags mark holes in ground).
- Remove any unwanted invasive plants.
- Mow if area is covered in tall (one foot or greater) herbaceous plants, being careful to not mow any vegetation, shrubs, or trees that are to be retained.
- Dig several test holes to determine how hard ground is for installing plants. This may affect number of volunteers needed and/or length of planting event.
- Consider parking and bathroom (portable toilets or nearby facility) accommodations for volunteers.

13. Prepare supplies

- Buckets
 - » Estimate one five-gallon bucket per 50 to 100 seedlings. The seedlings should be in buckets of water one to three hours before volunteers arrive to ensure they are well hydrated.
 - » Municipal partners (Parks, Public Works) may have these for loan or ask subset of volunteers/supervisors to bring.
- Shovels
 - » Provide one shovel per volunteer. If volunteers are asked to bring their own shovels, still have on hand at least half the required number.
 - » Consider asking municipal partners if they have shovels to loan.
- Mulch (for any container and/or B&B plantings)
 - » Check with the municipal park or solid waste department for free mulch or ground up yard waste.
 - » Mulch to a depth of three inches around B&B and container plants.
 - » Determine mulch needs:
 - ◇ A three-foot diameter mulched area with a depth of three inches requires 1.75 ft³ of mulch.
 - ◇ 1 yd³ = 27 ft³
 - ◇ Most scoops at nurseries are three-quarter of a yd³.
- Gloves: Check with your municipality’s solid waste department or Keep America Beautiful affiliate for a donation of gloves or ask volunteers to bring them.
- Registration Area
 - » Tent: Consider setting up a pop-up tent where volunteers can register and supplies can be kept. It will provide a central operating point, bringing more organization to the event.
 - » Table, chair(s), registration materials, clip boards
 - » Nametags
- Snacks
 - » Use coolers for water to avoid bottled water waste. Ask volunteers to bring their own water bottle but have recyclable cups available.
 - » Carbohydrate/protein source (e.g., peanut butter crackers, cereal bars, fruit) should be available for those who may have blood sugar conditions.
 - » Sponsors may want to have event-end “celebration” snack for volunteers.

Required Mulch Amounts

# of Trees/ Shrubs (3-ft diameter around plant)	Cubic Yards (yd ³)	Scoops (0.75 yd ³)
10	0.65	~1
20	1.30	~2
30	2.60	~3

- Other
 - » First aid kit
 - » Sunscreen, bug spray (if needed)

14. Day of event actions

- Have all supplies on site and organized prior to volunteers arriving.
- Sign-in volunteers.
 - » A liability form may need to be completed if participating organizations and/or landowner deems it necessary. Youth volunteers may require a parent or guardian signature on the waiver (see Appendix F).
 - » Some volunteers may require verification of their service hours for clubs or classes. Have pre-made forms for service hour verification .
- Conduct volunteer training.
 - » Recognize partners, donors, and cooperating property owners.
 - » Introduce intent of buffer – functions and benefits.
 - » Review safety considerations.
 - » Demonstrate how to properly install plants. With a large group it may be necessary to break into smaller groups so that all can easily see the demonstration and ask questions.
- Consider establishing a planting “quality control” system for younger volunteers. For example, once a hole is dug, have volunteer raise their hand so supervisor can assess hole size to ensure it is of sufficient size. If not working in pairs, have supervisor hold tree upright as volunteer backfills soil into hole.
- Install plantings.
- Water container and B&B plants if ground is dry. No watering is required for bare root seedlings if planted during dormancy months.
- Mulch container and B&B plants to approximately a three-inch depth and a three foot circumference. Avoid mulch touching stems.
- Do final walk through of site to ensure all plants have been properly installed and that all tools and trash have been collected.
- Gather volunteers for a final thank-you and a group photo. Consider a final treat or gift for all to enjoy together as a thank-you.
- Take before and after pictures of the site from a fixed photo point to document changes to the site over time.
- Take “action” shot photos of volunteers planting along with a group photo to share via internet (e.g., Facebook) and for the media.

Buffer Planting Project Sample Time Line	
2015	
September	<ul style="list-style-type: none"> • Conduct preliminary partner meeting
October	<ul style="list-style-type: none"> • Conduct “windshield survey” of potential buffer sites • Contact landowners to discuss planting project feasibility (i.e., Is the landowner supportive of the riparian planting and willing to ensure that the riparian buffer will be protected?) • Rate and rank potential buffer sites; select buffer site
November	<ul style="list-style-type: none"> • Work with landowner on planting plan • Set a planting date
December	<ul style="list-style-type: none"> • Order seedlings (ask for delivery one week before planting)
2016	
January	<ul style="list-style-type: none"> • Scout out sources of container/B&B stock if needed • Identify number of volunteers/supervisors needed & develop volunteer recruitment strategy • Conduct partner meeting to: review planting plan; discuss volunteer recruitment; who can help with prep day; supply list (who can bring what) • Last two weeks of January begin volunteer recruitment • Install yard sign at site advertising the event and notify neighbors.
February	<ul style="list-style-type: none"> • By first week, order container/B&B plants • Feb. 1 - Call Tennessee811 • Feb. 6 - Site Preparation Day – Remove invasives, trash...
February 13	BUFFER INSTALLATION EVENT
February 20	Rain Date (call to extend 811 ticket if rain date must be used)

The Tennessee Urban Riparian Buffer Handbook Series

This handout is one of a series of supporting appendices to the **Tennessee Urban Riparian Buffer Handbook**. To download go to: <http://tn.gov/agriculture/topic/ag-forests-urban>

- A. The Tennessee Urban Riparian Buffer
- B. Tennessee Riparian Buffer Site Assessment
- C. Creating a Tennessee Urban Riparian Buffer
- D. Tennessee Native Riparian Plants List
- E. The Threat of Invasive Plants to Tennessee Urban Riparian Buffers
- F. Organizing and Conducting a Riparian Buffer Community Planting
- G. Properly Installing Plants: How to Plant Trees and Shrubs

Sample Liability Form VOLUNTEER WAIVER

Thank you for volunteering to help with the *[insert location or event name]* buffer planting. Please read, complete, and sign the following form to participate in this event.

VOLUNTEER INFORMATION (PLEASE PRINT CLEARLY)

Name: _____

Address: _____

Phone or email: _____
(Optional if you would like us to contact you for future volunteer event)

EMERGENCY CONTACT INFORMATION

Name: _____

Relationship to Volunteer: _____ Phone: _____

VOLUNTEER AGREEMENT

As a volunteer, I release and hold harmless [insert all partners] and their successors from any and all claims, costs, suits, actions, judgments or expenses upon any damage, loss or injury to me or to my property which may arise from this volunteer event.

I acknowledge that I am fully aware of any and all risks posed by these volunteer activities and that I have no medical condition that prevents me from engaging in them.

I also give permission to be photographed by project partners or the media for use in printed materials, through the internet or through other media outlets.

In signing below, I acknowledge that I have read and understand this volunteer agreement.

Signature: _____

NOTE: If the volunteer is under the age of 18, a parent or legal guardian must sign.

Parent Signature: _____

To download an editable version (in MS Word format) go to:
<http://tn.gov/agriculture/topic/ag-forests-urban>

Sample Project Check List

Include date completed and related notes

- Buffer plan completed _____
 - ◇ Site inventory
 - ◇ Planting plan
- Funding secured _____
- Plants ordered _____
- Volunteers recruited & advised of proper clothing and footwear _____
- Easements and property boundaries marked _____
- Tennessee811 completed _____
- Neighbors notified and/or notification yard signs installed _____
- Pre-photos of site are taken _____
- Site prepared – mowed, invasives removed, safety hazards eliminated and/or marked _____
- Press releases completed and sent _____
- Supplies and tools purchased or borrowed _____
 - ◇ Registration tent, tables, chairs
 - ◇ Volunteer waivers, pens, clipboards, nametags
 - ◇ Port-a-pot arranged, if needed
 - ◇ Coolers for drinking water, cups, snacks
 - ◇ First aid kit, sunscreen
 - ◇ Plants
 - ◇ Mulch, if needed
 - ◇ Buckets
 - ◇ Shovels
 - ◇ Wheelbarrows
 - ◇ Gloves
 - ◇ Trashbags
 - ◇ Water for container and/or B&B trees and shrubs if needed
- Post-photos of site and volunteers are taken _____

To download an editable version (in MS Word format) go to:
<http://tn.gov/agriculture/topic/ag-forests-urban>

Tree Planting Event Marketing Signage Flyer Template

To download an editable template (in MS PowerPoint format) go to:
<http://tn.gov/agriculture/topic/ag-forests-urban>

**JOIN US FOR A *(insert stream name)*
TREE PLANTING!**

Date: _____

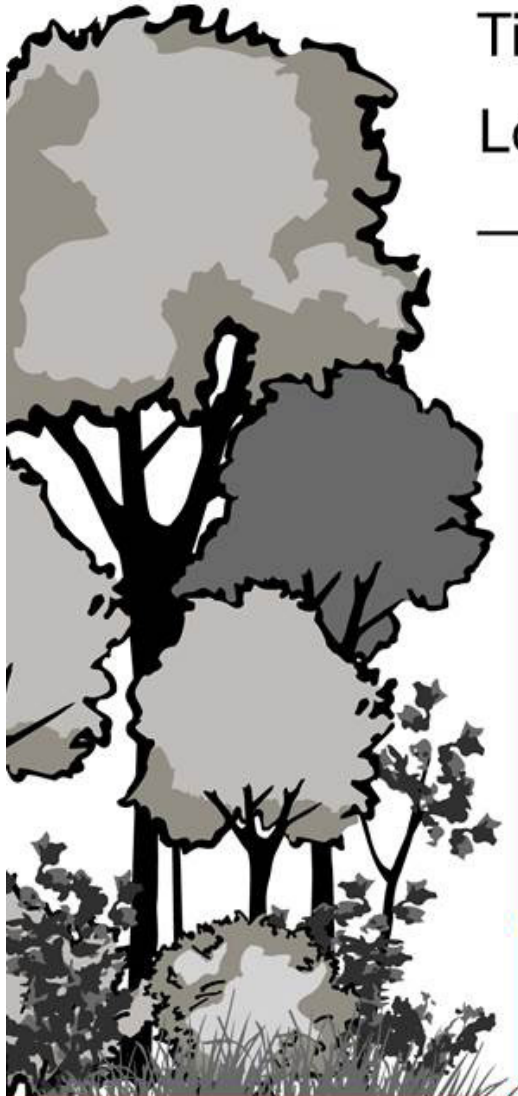

Time: _____

Location: _____

On how to volunteer
call: (____) ____ - ____

*We will be planting native trees
and shrubs to create a healthy
forested streamside buffer.*

Benefits include:

- *A cleaner stream by reducing streambank erosion and filtering pollutants*
- *Enhanced aquatic and terrestrial habitats*
- *Improved air quality*

For more information about riparian
buffers, visit _____

Sponsor Logos

Tree Planting Event On-Site Marketing Signage Template

To download an editable template (in MS PowerPoint format) go to:
<http://tn.gov/agriculture/topic/ag-forests-urban>

**JOIN US FOR A *(insert stream name)*
TREE PLANTING!**

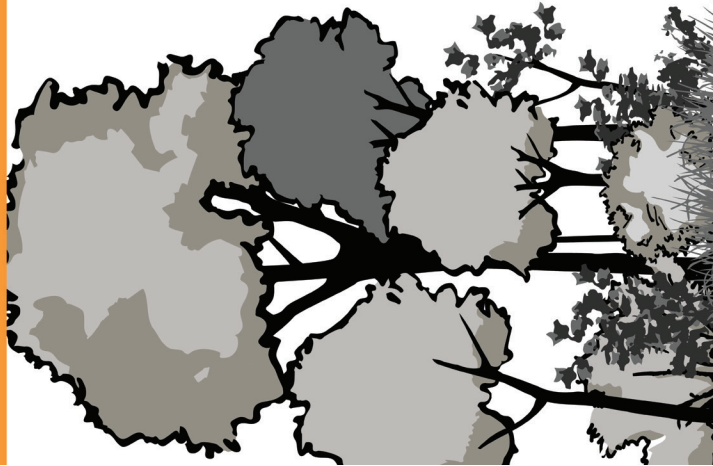

DATE: _____

On how to volunteer call: _____

This property will be planted with native trees and shrubs to create a healthy forested streamside buffer. The trees and shrubs will keep _____ clean by reducing streambank erosion and filtering pollutants. They will also provide aquatic and terrestrial habitat and improve air quality.

For more information about riparian buffers, visit _____

Sponsor Logos

G. Tennessee Urban Riparian Buffers: How to Plant Trees and Shrubs

Preparing a Site for a Planting

The state of Tennessee requires that any landowner who digs on their property first contact Tennessee811 to have all underground utilities marked. This is done by calling 811 or submitting an e-request at <http://www.tnonecall.com>. Prior to the call, clearly mark the outline of the proposed buffer area to be planted with white flags, paint or stakes.









The TN One-Call website, <http://www.tnonecall.com>, contains a full description of this service. Key points include:

- The call must be made at least three business days prior to beginning digging.
- You will be provided a ticket number with a start date and time on it. The ticket is good for 15 days. That is, you are only allowed to dig during those 15 days.
- The utility companies will mark utilities using a required color coding system and will be identified by paint, stakes or flags.
- If any digging extends beyond the 15 days, you have to call 811 to obtain an extension on the ticket time.
- It is important to explain to children that the flags are not to be removed.
- Avoid digging within 24 inches on either side of the markings, or 10 feet within side of water or sewer lines. Check with your local utilities for additional digging stipulations adjacent to lines.

On-site tasks that may need to be done include:

- **Removing excess debris** like logs, branches or trash.
- **Mowing herbaceous materials** that are one foot or higher to make it easier to plant and to reduce initial competition for the bare root seedlings. It may be necessary to use a brush hog if the vegetation is particularly dense. Clearly mark any vegetation, shrubs or trees that are NOT to be mowed.
- **Removing invasive vegetation.** Certain nonnative plants like bush honeysuckle and Chinese privet, are often highly invasive in riparian areas and may need to be removed to allow for planting. See **Appendix E** for more information on how to remove invasive plants.

APWA Uniform Color Code for marking underground utility lines.

COLOR		Utility Line
WHITE		Proposed Excavation
PINK		Temporary Survey Markings
RED		Electrical Power Lines, Cables, conduit and Lighting Cables
YELLOW		Gas, Oil, Steam, Petroleum or Gaseous Materials
ORANGE		Communication, Alarm or Signal Lines, Cables or Conduit
BLUE		Potable Water
PURPLE		Reclaimed Water, Irrigation and Slurry Lines
GREEN		Sewer and Drain Lines

Properly Installing Plants

A common adage among gardeners is “for a dime-size plant, dig a dollar-size hole.” With that in mind, following are steps to properly installing bare root seedlings and container or balled and burlap plants.

Bare Root Seedlings

- Keep roots damp, cool and out of the sun until ready to be planted.
- One to three hours prior to planting, remove seedlings from their shipping bags and place in buckets of water to hydrate the roots. Keep roots out of the direct sun.
- At the seedling planting site, remove about a two foot diameter circle of vegetation with a shovel or mattock. Consider composting this removed green waste or simply set it aside.
- Dig the hole two feet wide and deep enough for roots to remain straight.
- If a hole cannot be dug two feet deep, dig a horizontal trench out from the planting hole deep enough to bury long roots.
- Set aside excavated soil for backfill. It may be helpful, especially in areas of higher dense turf, to place the excavated soil into a five-gallon bucket so that it is not lost into the vegetation or turf.
- Set seedling in hole, ensuring it is straight and that the slightly swollen area just above where the roots begin (root flare) is about level with surface.
- While holding the seedling erect, backfill the hole using the excavated soil, being sure there are no exposed roots. Do not replace the excavated turf back around or near the seedling.
- Lightly tamp soil to eliminate air pockets, but do not compact the soil.

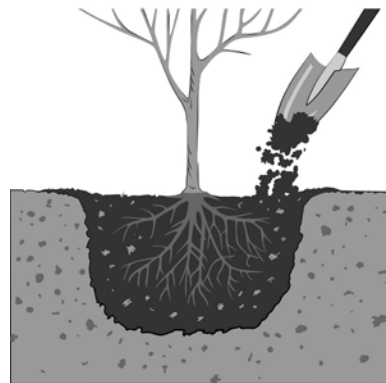
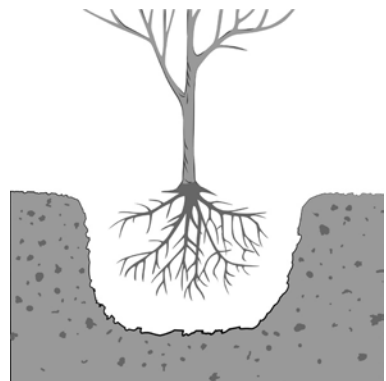

Container-Grown or Balled and Burlapped (B&B) Plants

- Protect plants from wind damage in transport to the planting site.
- Keep plants well watered until ready to plant.
- Dig hole twice the width of the container or root ball with sloping or flared sides wider at the top than at the bottom.
- Set container or B&B plant into hole to see if it is the right width and depth before removing the container or burlap. Adjust hole size as needed.

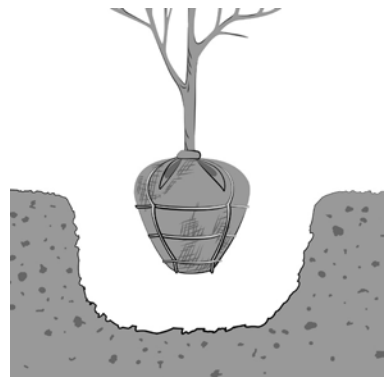

- **Container-grown:** Remove plant from container. If roots are “root bound” (e.g., roots wound tightly around the outside of the soil ball), tease or prune the roots loose. Place root ball in hole, spreading roots out.
- **Balled and burlapped (B&B):** Place trees in hole. Remove wires, strings or pins holding the burlap. Fold the burlap down the sides of the ball to the bottom of the hole. Burlap may be removed completely if done without disturbing the root ball.
- Position the tree so the root flare is at or just above the ground level and be sure that all roots will be buried when hole is backfilled.
- Backfill with soil, making sure trunk is straight. Do not use soil amendments.
- Tamp soil to eliminate air pockets.
- Apply three to four inch depth of mulch around the tree, keeping the mulch several inches away from the trunk. Mulch mounded high against trunks (a.k.a. ‘volcano mulching’) can promote plant disease.
- Stake large trees in windy areas. Remove staking after one year.
- Water, as needed, particularly through first growing season. Most plants ideally need about one inch of water per week. The following table converts this amount into gallons per week based on the canopy spread of the shrub or tree. These amounts may be doubled during extremely hot weather.



Plant Water Needs

Most plants ideally need about one inch of water per week. This table converts this amount into gallons per week based on the spread of the tree or shrub.

Water Amount (gallons/week)	Canopy Spread (feet)
0.5	1
2.0	2
4.5	3
8.0	4
12.0	5
18.0	6

During hot weather these amounts may double.

Maintaining and Protecting a Buffer Planting

Informing Your Neighbors: It is advisable to contact adjacent landowners prior to the planting to inform them of the buffer planting. By including a description of how the buffer's appearance will change over time, you can help to alleviate concerns neighbors may have over perceived property neglect.

Managing Vegetation: Once a riparian buffer is planted, it is generally recommended not to mow. "Weeds" will soon begin to colonize around the seedlings and take on more of an unkempt appearance. It is nature taking its course with early succession beginning. During this time it may be helpful to "maintain" the outer edge of the buffer, keeping vines and weeds from overtaking the edge trees and shrubs, and perhaps planting or sowing native wildflowers along the buffer edge.

- **Physical Access:** Paths will need to be periodically mowed or brush cut. Consider mowing to a height no less than four to six inches.
- **Visual Access:** Low-growing shrubs may be installed to create "view windows" to the waterway. It is inevitable that outside seed sources will migrate in and that periodic removal of unwanted species will be required. By walking these areas once or twice a year, newly germinated seedlings can be easily removed.

Removing Invasive Plants: Invasive plants can crowd out installed ones if not removed. Consider walking the buffer area twice a year to look for unwanted plants. Walking on an imaginary grid can help ensure the entire area is covered. When identified young, many invasive plants can be hand pulled (see Appendix E).

Long-Term Protection: It may be necessary to mount several signs along the outer edge of the planted area that indicate the buffer is a "no mow zone" and/or install temporary fencing to reinforce this message. The "now mow" sign can include information on buffer functions and a municipality's water quality hot line number.

The Tennessee Urban Riparian Buffer Handbook Series

This handout is one of a series of supporting appendices to the **Tennessee Urban Riparian Buffer Handbook**. To download go to: <http://tn.gov/agriculture/topic/ag-forests-urban>

- A. The Tennessee Urban Riparian Buffer
- B. Tennessee Riparian Buffer Site Assessment
- C. Creating a Tennessee Urban Riparian Buffer
- D. Tennessee Native Riparian Plants List
- E. The Threat of Invasive Plants to Tennessee Urban Riparian Buffers
- F. Organizing and Conducting a Riparian Buffer Community Planting
- G. Properly Installing Plants: How to Plant Trees and Shrubs

Riparian Buffer On-Site Educational Signage Template

To download an editable template (in MS PowerPoint format) go to:
<http://tn.gov/agriculture/topic/ag-forests-urban>

Riparian Buffer Under Construction

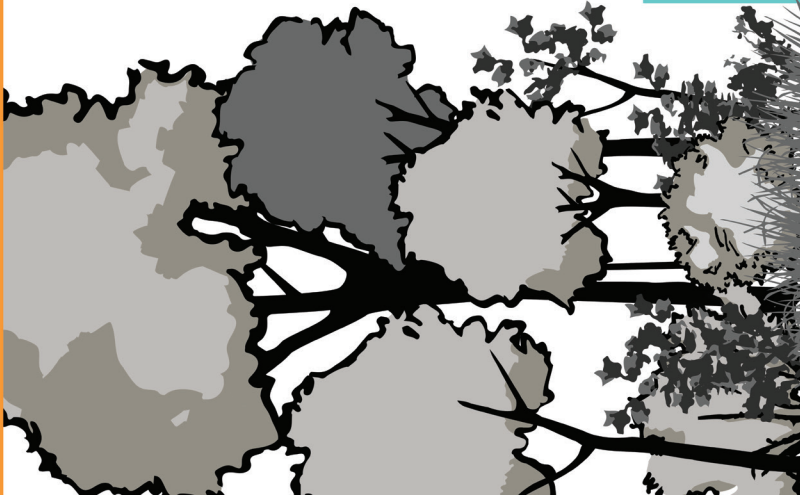

This property is being planted with native trees and shrubs to create a healthy forested streamside buffer. The trees and shrubs will keep [stream name] clean by reducing streambank erosion and filtering pollutants. They will also provide aquatic and terrestrial habitat and improve air quality.

Be aware that initially this area may have a messy look. It is in its early ecological stages. As the plants mature, they will begin to shade out undergrowth.

For more information about riparian buffers, visit
[organization's name] website at [organization's website]

Sponsor Logos

This page intentionally left blank

